

# WearDetect

## Oil Debris Sensor

# User Manual

### Sensor with display

4212-PK-145  
4212-PK-146  
4212-PK-147



### Sensor without display

4212-PK-148  
4212-PK-149  
4212-PK-150



### Inflow fitting

4212-00-160-100  
4212-00-160-150  
4212-00-161



## Contents

<b>1. Product description</b>	<b>5</b>
1.1 Product Types	6
1.2 Product Fittings	7
<b>2. Getting started</b>	<b>8</b>
2.1 Configuration software	8
2.2 Sensor Configuration - Computer connection	8
2.2.1 Sensors with display (4212i)	8
2.2.2 Sensor without display models (4212)	9
<b>2.3 Electrical Connections</b>	<b>9</b>
2.3.1 Power supply	9
2.3.2 Connections - Sensors with display (4212i)	9
2.4 Install FTDI drivers	10
2.5 Launch the Oil Debris Sensor Configurator Software	11
2.6 Bench system test	12
<b>3.0 Operating Instructions</b>	<b>14</b>
3.1 Configuring the Sensor	14
3.1.1 Sensor Type	14
3.1.2 Sensor Output	14
3.1.3 Water Contamination /Temperature Channel	15
3.2 Inhibit Outputs during Configuration	15
3.2.1 Disable Fine Channel	15
3.2.2 Disable Coarse Channel	15
3.2.3 Disable Water Contamination/Temperature Channel	15
3.3 Sensor Position Calibration	16
3.3.1 Zero/Tare	17
<b>4. Advanced Settings</b>	<b>18</b>
4.1 Full Scale Fine	18
4.2 Full Scale Coarse	19
4.3 Manual Adjustment	21
4.4 Oil Calibration	21
4.4.1 Set Water Contamination Reference	25
4.4.2 No Oil Threshold	25
4.4.3 Water Contamination Threshold	25
4.4.4 Filter Time (seconds)	25
4.4.5 Set Clean Oil Reference	25

4.5 Temperature	26
4.6 Analog Output	26
4.6.1 Error Level	26
4.6.2 Zero level	27
4.6.3 Full Scale Level	27
4.6.4 Inhibit Level	27
4.7 CAN	27
4.7.1 Function Instance	27
4.7.2 ECU Instance	27
4.7.3 Industry Group	28
4.7.4 Vehicle System Instance	28
4.7.5 Vehicle System	28
4.7.6 Function	28
4.7.7 Manufacturer Code	28
4.7.8 Identity Number	28
4.7.9 NAME	28
4.8 PGN/ID	29
4.8.1 Priority	29
4.8.2 Data Page	29
4.8.3 PDU Format	29
4.8.4 PDU Specific	29
4.8.5 PGN	30
4.8.6 CAN ID	30
<b>5.0 Miscellaneous settings</b>	<b>31</b>
5.1 LED Brightness (Sensors with display Only)	31
5.2 Exporting a Configuration File	31
5.3 Importing a Configuration File	31
5.4 Restore Factory Defaults	31
<b>6. Installation</b>	<b>35</b>
6.1 Sensor Location	35
6.2 Sensor Head	35
6.3 Sensor Electronics	37
6.3.1 Sensor with display Electronics Mounting	37
6.3.2 Sensors without display Electronics Mounting	37
6.3.3 Grounding the enclosure	38
6.4 Cabling	38
6.4.1 Cable Protection: Sensor with display	39
6.5 Sensor Head Fitting Chart	40
6.6 Inflow Sensor Head Fitting (Optional)	41

For use with WearDetect Oil Debris Sensor and accessories

### 7. Specifications

7.1 Sensors with display: 4 – 20 mA output	43
7.2 Sensors with display: 0.10V Voltage output	44
7.3 Sensors with display: J1939 CAN output	46
7.4 Sensors without display: 4 – 20 mA output	48
7.5 Sensors without display: 0-10V Voltage output	48
7.6 Sensors without display: J1939 CAN output	49
7.7 Environmental	51

### 8. Maintenance

8.1 Cleaning	52
8.2 Servicing	52
8.3 Corrosion	53
8.4 Sealing	53
8.5 Fault-finding	53
8.5.1 Troubleshooting	53
8.5.2 Status (error) codes	54
8.5.3 Communications (error) codes	54
8.5.4 Returning a Faulty Sensor	54

### 9. Appendices

9.1 Maximum Range Coarse Debris	55
9.2 Maximum Range Fine Debris	55
9.3 Interaction between Coarse and Fine Channels	55
9.4 Guideline Oil Reference Number	56
9.5 Grounding Schemes and Recommendations	56
9.6 Oil Debris Sensor parts	57
9.7 Packaging	57
9.8 Accessories	57
9.9 Product variants	58
9.9.1 Optional	58
9.10 Sensor De-commissioning	58
9.10.1 Uninstall the Oil Debris Sensor Configurator App	58

For use with WearDetect Oil Debris Sensor and accessories

### 1. Product description

WearDetect Oil Debris Sensor is designed to detect particles of metal in oil that have originated from worn or broken machinery such as gears. It attracts and collects this debris and records the amount collected. This serves as an early warning of impending mechanical failure. The active part of the Oil Debris Sensor is the sensor head. This part is immersed in the oil being monitored. It has two sensing elements, a magnetic element at the head of the sensor head which detects ferrous material (debris) and a dielectric element (\*model specific) at the foot of the sensor head which detects the presence of oil.

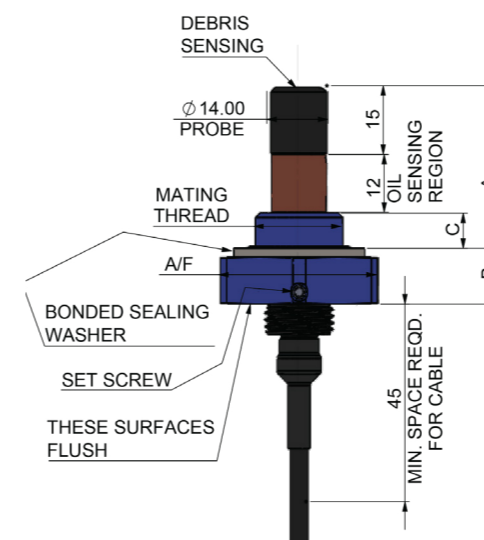

The WearDetect provides continuous real-time monitoring of ferrous debris that it captures from the lubricating oil.

Ferrous particles are deposited into the oil from gears, bearings and other metallic contacting surfaces. The presence of excessive ferrous debris provides an indication that an overload condition, lubricant contamination, lubricant degradation or lack of lubricant volume has caused the bearings and/or gears to begin to break down.

The reporting of these features can provide an early indication of potential breakdowns and is key to implementing effective planned preventative maintenance.

The WearDetect attracts ferrous debris within the oil by means of a permanent magnet, non-ferrous debris may be deposited on the sensor by other means, for example by mounting the sensor in a location where debris would normally gather. Electronics within the Oil Debris Sensor detect the presence and type of debris, quantifying it as 'fine' (powdered) or 'coarse' (chippings) and reports a signal associated with the volume of each type of debris. Other functions of the sensor measure the temperature and the dielectric of the oil for the purpose of detecting a significant change in the dielectric value. Such changes will occur if the oil is not present (oil leak) or if the water content in the oil is significant.

# WearDetect

## Oil Debris Sensor

For use with WearDetect Oil Debris Sensor and accessories



WearDetect with coarse and fine debris attracted to the sensor head face.

\* Please note this functionality is not available to sensors using an NPT fitting.

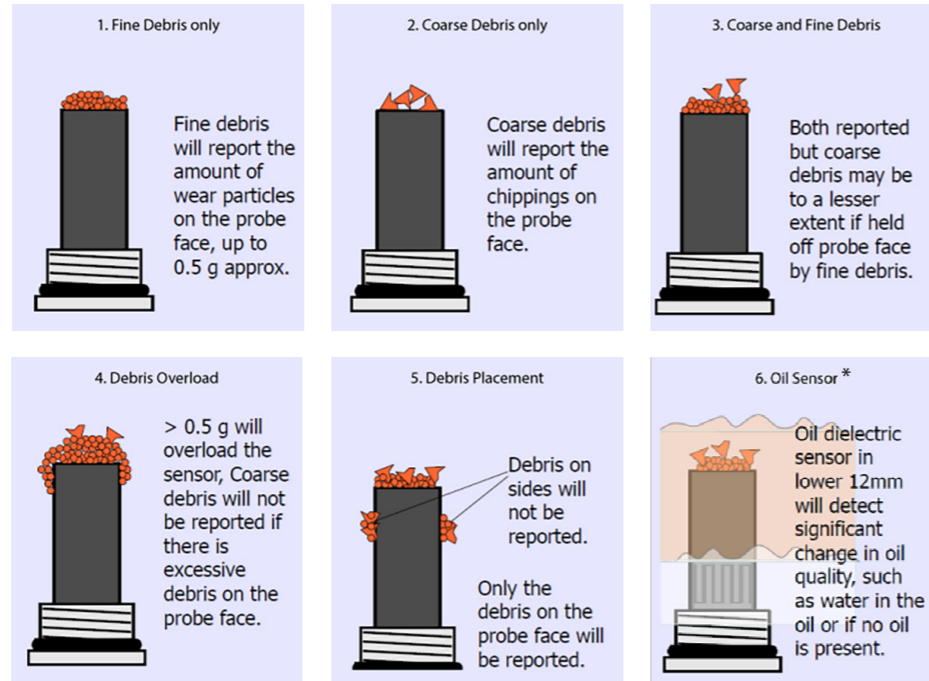

### 1.1 Product Types

WearDetect is available with one of three different output types, either a 4-20mA current output, a 0-10V voltage output or a digital CAN output either with or without display.

#### ■ Sensors without display (4212)

The sensor head is connected to an in-line electronics module.



Scan for Datasheet

#### ■ Sensors with display (4212i)

The sensor head includes a remote display module.



Scan for Datasheet



4212-PK-148 Oil Debris Sensor without display 4-20mA  
4212-PK-149 Oil Debris Sensor without display 0-10V  
4212-PK-150 Oil Debris Sensor without display CAN



4212-PK-145 Oil Debris Sensor with display 4-20mA  
4212-PK-146 Oil Debris Sensor with display 0-10V  
4212-PK-147 Oil Debris Sensor with display CAN

# WearDetect

## Oil Debris Sensor

For use with WearDetect Oil Debris Sensor and accessories

### 1.2 Product Fittings

WearDetect is supplied for use in many different types of equipment where sensor thread size and type vary. As standard each sensor is supplied excluding the sensor fitting adaptor to allow maximum flexibility at installation.

Fitting adaptors are available with metric, BSPP, UNF and NPT thread fittings to cater for a wide range of applications. Please refer to the product data sheet for a list of the available thread sizes or contact us for more information.



Sensor head with separate thread fitting



Sensor head with thread adaptor fitted

### Optional Inflow installation

WearDetect can also be fitted within an oil bypass line using the 4212-PK-502 M20 x 1.5 fitting. Available either as shown with isolation valves included or with the central pipe fitting only, this additional installation option can be used with all WearDetect models. See section 6 for detailed information.



For use with WearDetect Oil Debris Sensor and accessories

### 2. Getting started

To set up the sensor for optimum operation, Gill recommend downloading and running the WearDetect software from [www.gillsc.com/support](http://www.gillsc.com/support). The following steps cover all models in the range irrespective of fitting type.

#### 2.1 Configuration software

Download the WearDetect software observing the minimum computer operating system requirements below:

The minimum operating system requirements are:

- 32-bit (x86) or 64-bit (x64) processor
- Windows® 7 or later
- 1 Gb RAM
- 500 Mb disk space



Scan for Video tutorial

#### 2.2 Sensor Configuration - Computer connection

Connect the sensor using a micro USB to USB 2.0 cable from the sensor to the computer for configuration dependent on model as follows;

*Note: In order for the USB communications to occur the Oil Debris Sensor must have power, as it cannot be powered from the USB socket.*

##### 2.2.1 Sensors with display (4212i)

Remove the lid by undoing the 4 lid retaining screws and allowing the enclosure to open. The lid is retained by a metallic banding strap for protection. The micro USB connector is located on the underside of the lid as shown in the picture right.

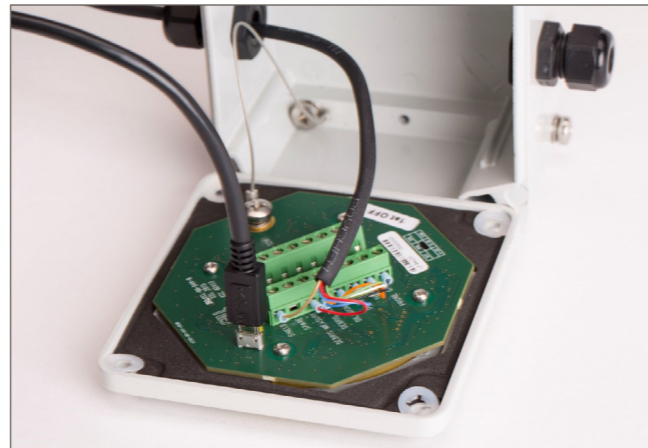

*Note: On completion of configuration, remove the cable assembly and re-assemble the lid ensuring any sealing gasket is correctly located and the screws are fully tightened to 4Nm +/-0.4Nm during re-assembly.*

For use with WearDetect Oil Debris Sensor and accessories

##### 2.2.2 Sensor without display models (4212)

Take out the 4 lid screws (Torx Tx6) and remove the lid to expose the sensor electronics. Ensure the rubber seal remains in place. The micro USB connector is located on the PCB as shown in the picture below.

*Note: On completion of configuration, remove the cable assembly and re-assemble the lid ensuring any sealing gasket is correctly located and the screws are fully tightened to 0.5Nm +/-0.05Nm during re-assembly.*

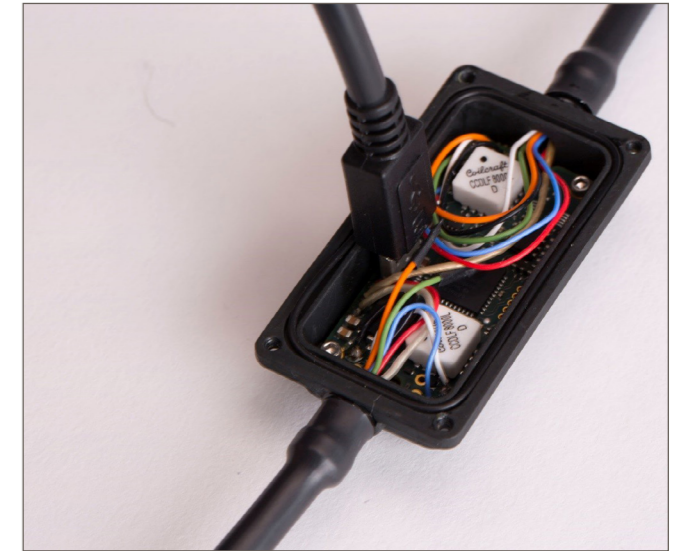

#### 2.3 Electrical Connections

##### 2.3.1 Power supply

See section 5 Specifications, for the applicable power supply ranges appropriate to your model variant.

*Note: for voltage devices the analogue output is limited by the supply voltage provided to power the sensor and a minimum 0.7 V power supply headroom above the desired analogue output is recommended for stable sensor output.*

##### 2.3.2 Connections - Sensors with display (4212i)

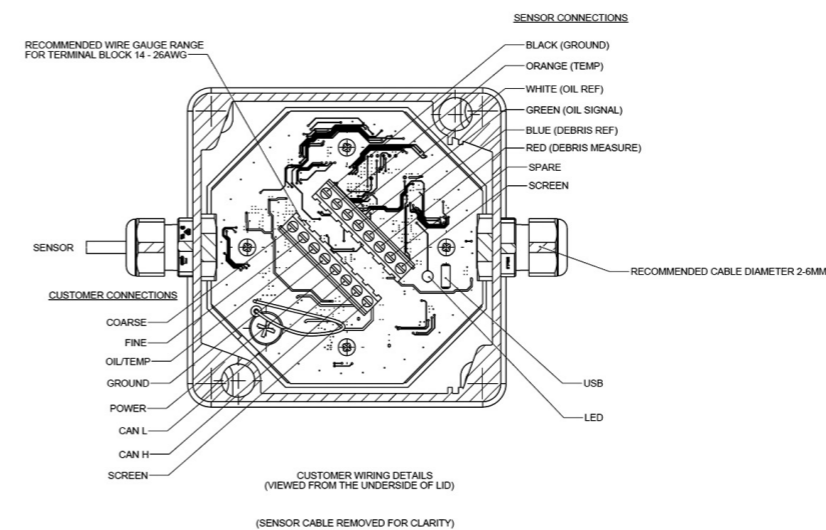

Fit wires with the bootlace ferrules provided prior to termination into the terminal block.

For use with WearDetect Oil Debris Sensor and accessories

### 2.3.3 Connections - Sensor without display models (4212)

#### 2.3.3.1 Connections - Analogue 4-20mA & 0-10V

Wire Colour	Designation
White	Fine
Green	Coarse
Orange	Oil/Temp
Black	Power Gnd (V-)
Red	Power (V+)
Blue	(Not Connected)
Clear	Screen

#### 2.3.3.2 Connections - Digital CAN J1939

Wire Colour	Designation
White	Can H
Blue	Can L
Orange	(Not Connected)
Green	(Not Connected)
Red	Power (V+)
Black	Power Gnd (V-)
Clear	Screen

### 2.4 Install FTDI drivers

Once connected, your computer may automatically recognise the Oil Debris Sensor; if not you may be prompted to search for FTDI driver software, in which case allow your Windows® software to automatically search Windows® Updates for the drivers. Note: an internet connection is required to obtain driver updates.

For manual installation of the FTDI driver software, follow the steps below:

FTDI drivers can be downloaded at <https://ftdichip.com/drivers/vcp-drivers/>

Open Control Panel>Device Manager and select the unidentified USB serial port from the list and click the right hand mouse button to select 'Properties' from the drop down menu. Select the Driver tab > Update driver select > Browse my computer for driver software and select the folder location of the FTDI driver that you downloaded. Select the folder and click 'Next' to update the driver. The FTDI driver should now be installed.

For use with WearDetect Oil Debris Sensor and accessories

### 2.5 Launch the Oil Debris Sensor Configurator Software

Launch the configurator software application by double clicking the Gill Oil Debris Sensor Configurator Icon located on your desktop, start menu or your program file location selected during installation. The following home screen should appear:

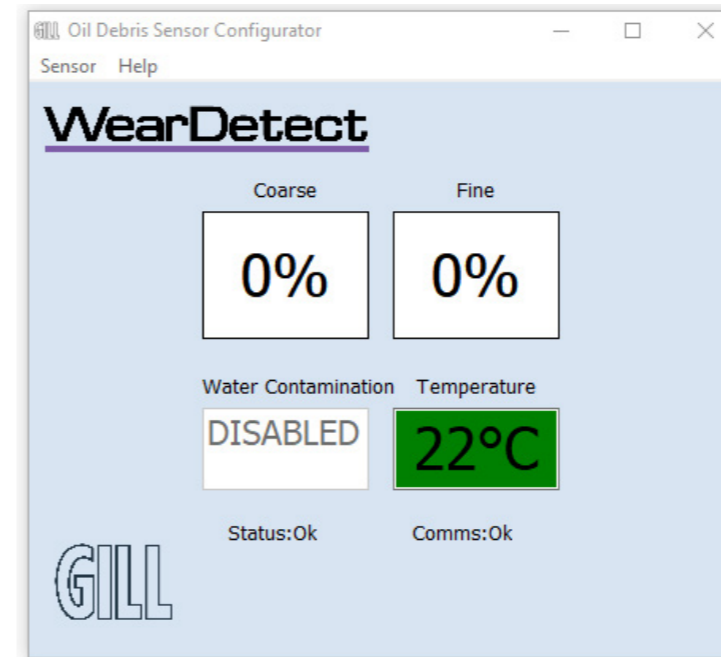

If there is a fault with the connection between the PC and the Oil Debris Sensor, then you will see the following message:

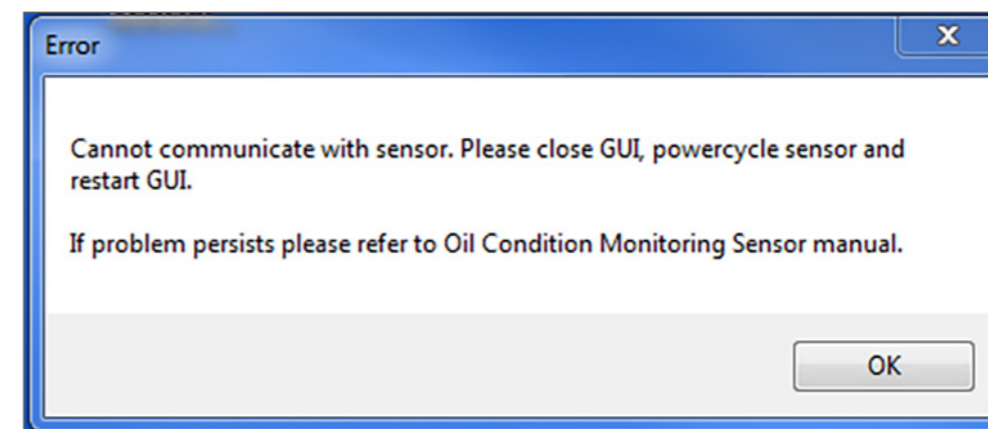

Check the cable is correctly inserted at both ends and that the sensor is powered. It is also possible that the installation of the device drivers has not yet been completed. Re-starting usually clears the problem. If not, then check that sufficient power is being supplied to the sensor.

For use with WearDetect Oil Debris Sensor and accessories

### 2.6 Bench system test

It is recommended that the :is functionally tested on the bench prior to installation. From the start screen shown on the previous page, select the Sensor menu and then select 'Restore Factory Defaults'. There are 3 possible pre-set debris conditions available within the software which can be selected appropriate to your system; Small, Medium and Large. These set the coarse and fine scales according to the size/quantity of debris (see values in the table below).

Parameter	Sensitivity Scale		
	Small	Medium	Large
100% FSD Coarse	1 x 3mm Chrome steel ball bearing	1 x 5mm Chrome steel ball bearing	4 x 5mm Chrome steel ball bearing
100% FSD Fine	0.1g ironpowder	0.25g ironpowder	0.5g iron powder

Gill can provide a debris test strip with measured amounts of fine and coarse debris impregnated in epoxy to assist with bench testing. If you have collected samples from a previously failed system then this debris can be placed on the end of the sensor to scale the sensitivity to your specific system requirements.



Debris Strip  
(Part No. 4212-00-063)

The default configuration settings as shipped from the factory are defined below:

Parameter	Sensitivity Scale
	Small
Water Contamination / Temperature Channel	Water Contamination (alarm)
Inhibit Outputs During Configuration	Switched Off
Disable Fine Channel	Switched Off
Disable Coarse Channel	Switched Off
Disable Water Contamination / Temperature Channel	Switched Off
100% FSD Coarse	1 x 3mm Chrome steel ball bearing

For use with WearDetect Oil Debris Sensor and accessories

Parameter	Sensitivity Scale	
	Small	
Water Contamination	Reference Oil Type	Mineral Oil
	No Oil Threshold	1010
	Water Contamination Threshold	985
	Filter Time	1 Second
Temperature Status	High Temperature Alarm	+150 °C
	Low Temperature Alarm	-26 °C
LED Brightness (Sensor with display models only)	Maximum	
0-10V Outputs	Error Level	0.0V
	0% FSD	2V
	100% FSD	10V
	Inhibit	1V
4-20 mA Outputs	Error Level	0 mA
	0% FSD	4 mA
	100% FSD	20 mA
	Inhibit	2 mA
Can Outputs (J1939)	Function instance	User Configured
	ECU Instance	User Configured
Can Outputs (J1939)	Industry Group	0000
	Vehicle System Instance	0000
	Vehicle System	0000
	Function	00ff
	Manufacturer Code	07ff
	Identity Number	0000
PGN/ID	NAME	User Configured
	Priority	0006
	Data Page	0001
	PDU Format	00ff
	PDU Specific	0000
	Address	User Configured
	PGN	User Configured
	CAN ID	User Configured

Note that the factory default sensitivity is always set to Small. Note also that, once the sensor head is installed on the equipment, there is the option of customizing the settings to suit the application (see Section 3.1) in which case these sensitivity settings no longer apply.

For use with WearDetect Oil Debris Sensor and accessories

### 3.0 Operating Instructions

#### 3.1 Configuring the Sensor

Select the Sensor>Configure option from the top pull down menu. Note that on the display model of the product, the green LEDs will turn to blue whilst configuring the sensor.

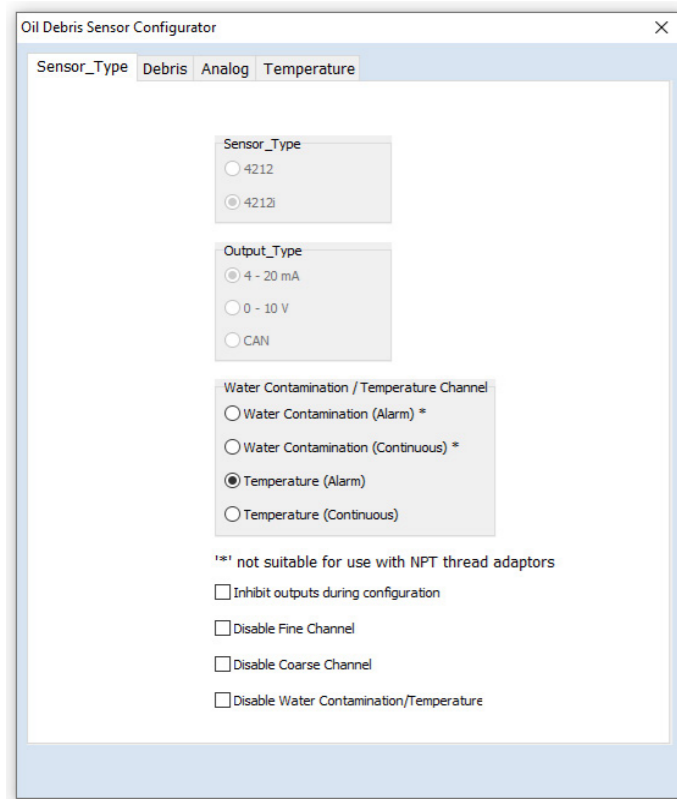

##### 3.1.1 Sensor Type

The sensor type is factory configured and is displayed for reference purposes only. The button references either the Sensor with display models (4212i) or the Sensor without display models (4212).

##### 3.1.2 Sensor Output

The sensor output type is factory configured and is displayed for reference purposes only. The button references either 4-20mA, 0-10V or CAN output types.

*Note: The home screen now reflects the options selected. Unused features shall be disabled in this window.*

For use with WearDetect Oil Debris Sensor and accessories

#### 3.1.3 Water Contamination /Temperature Channel

Select the required third channel output option by clicking the "Water Contamination" or "Temperature" button. On setting the 3rd channel status, the configuration tabs are automatically adjusted to display the selected channel options.

The 3rd channel status is set to Water Contamination by default.

*Note: If you have an NPT thread fitting, please change the default and select temperature.*

#### 3.2 Inhibit Outputs during Configuration

Select the "inhibit outputs during configuration" to fix the analogue outputs to a known state. This may be used to disable external alarm conditions during configuration and maintenance of the Oil Debris Sensor i.e. when an external PLC controller alarm status may be triggered while setting the Full Scale Deflection (FSD) level. The analogue output levels can be set by the user within the Analog Output tab>Inhibit level. On disabling the Inhibit outputs during configuration feature, the inhibit level is disabled from the Analog Output tab.

The "inhibit outputs during configuration" option is switched on by default and is set to 0.25 V for the voltage output versions and 2 mA for the 4-20 mA output versions.

##### 3.2.1 Disable Fine Channel

Select the "disable fine channel" option to make the fine channel inoperable. On disabling the fine channel option, setting of the fine channel is disabled from the Debris tab.

*Note: the home screen now reflects the options selected. Unused features shall be disabled in this window.*

The "disable fine channel" option is switched off by default, meaning the fine channel is enabled.

##### 3.2.2 Disable Coarse Channel

Select the "disable coarse channel" option to make the coarse channel inoperable. On disabling the coarse channel option, setting of the coarse channel is disabled from the Debris tab.

*Note: the home screen now reflects the options selected. Unused features shall be disabled in this window.*

The "disable coarse channel" option is switched off by default, meaning the coarse channel is enabled.

##### 3.2.3 Disable Water Contamination/Temperature Channel

Select the "disable fine channel" option to make the Water Contamination/temperature channel inoperable.



For use with WearDetect Oil Debris Sensor and accessories

The “disable Water Contamination/Temperature channel” option is switched off by default, meaning the channel is enabled in it’s out of the box condition.

### 3.3 Sensor Position Calibration

Select the Sensor pull down menu and then the Configure setting.

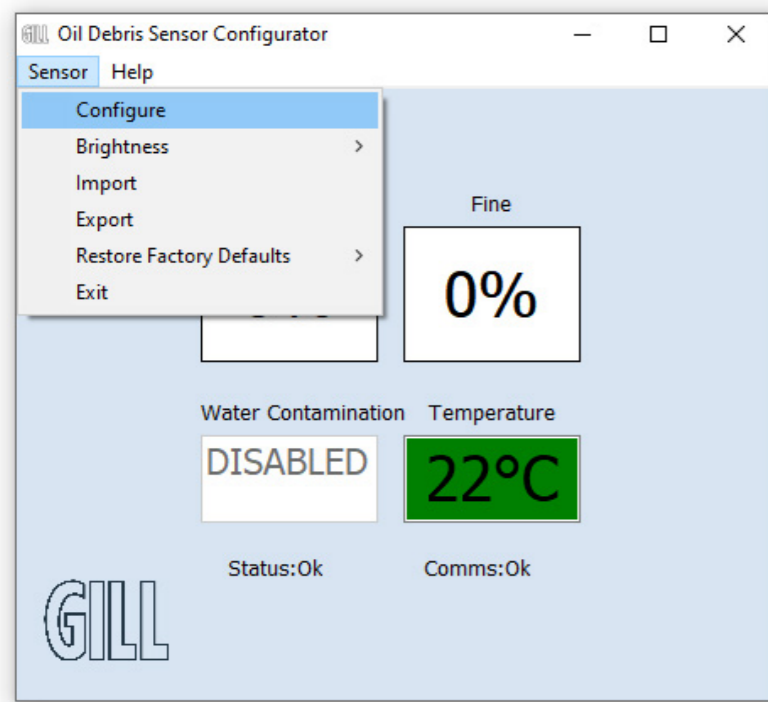

Select the Debris tab from this new window.

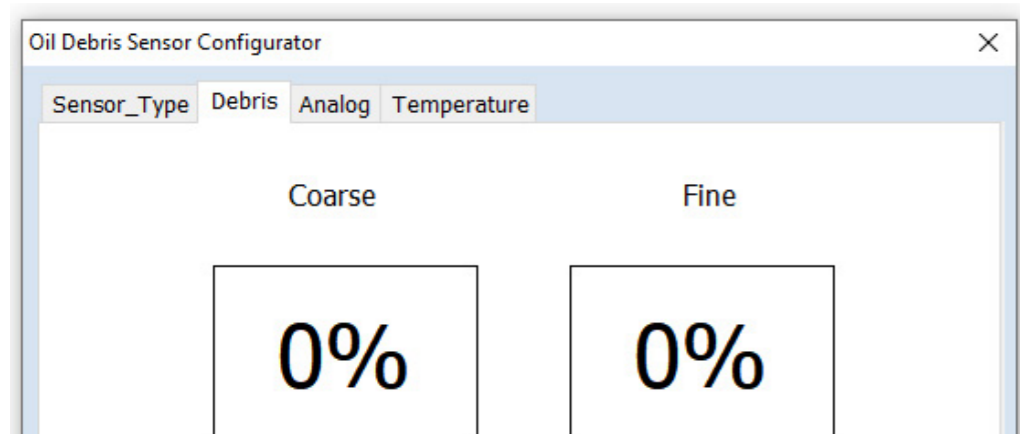

For use with WearDetect Oil Debris Sensor and accessories

### 3.3.1 Zero/Tare

The “zero/tare” function must be used if during installation the sensor develops an offset due to surrounding metalwork. This shall become evident if the sensor output is greater than the zero level specified by the user (>0%) without debris present following installation into the gearbox.

It is recommended that the zero/tare function is used at the start and end of every configuration and with all installations using the NPT fitting adaptors.

On this screen you will see three buttons labelled **Zero / Full Scale Coarse / Full Scale Fine**.

Press the “Zero” button to reset the sensor head.

*Note: the sensor is now configured with default settings. If further adjustment is required to fine tune the sensor to a particular application or if the default settings are not suitable, please refer to section 4. Advanced Settings.*

*Note: On completion of configuration, remove the cable assembly and re-assemble the lid ensuring any sealing gasket is correctly located and the screws are fully tightened to as per notes in section 2.2.1 & 2.2.2.*

For use with WearDetect Oil Debris Sensor and accessories

### 4. Advanced Settings

This section describes how the sensor may be configured for alternative settings. Access to debris and the type of oil used in the application is required to tune the sensor to the gearbox. Not all sections have to be configured if the default settings are acceptable.

#### 4.1 Full Scale Fine

The “full scale fine” operation will gauge the output of the sensor to the desired level with the maximum amount of fine debris applied to the sensor (100% Full Scale Deflection).

Add some fine debris to the sensor head (again this should represent what you would constitute to a 100% failure).

A fine value will now be displayed in the window.

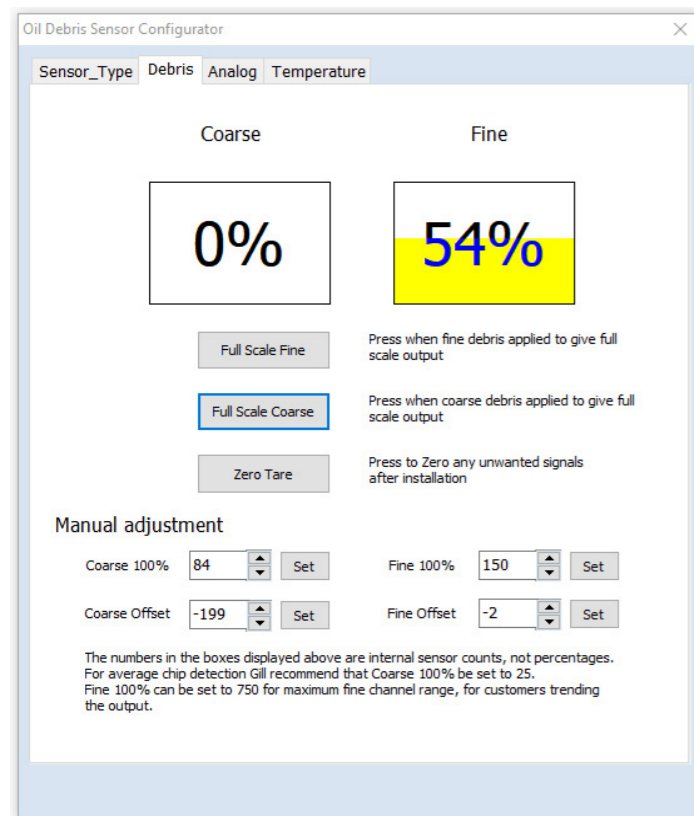

*Note: see Section 9 for the saturation point of fine debris.*

Press the “Full Scale Fine” Button and this will set this quantity of debris as 100%.

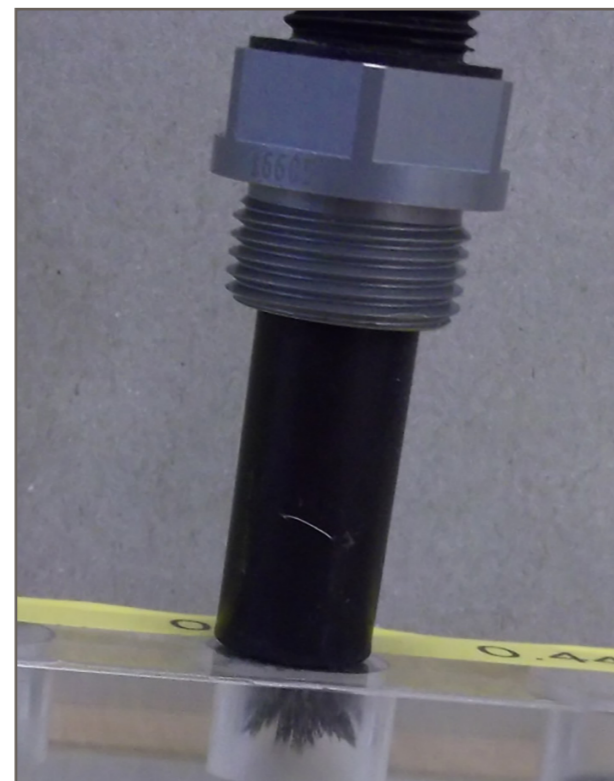

For use with WearDetect Oil Debris Sensor and accessories

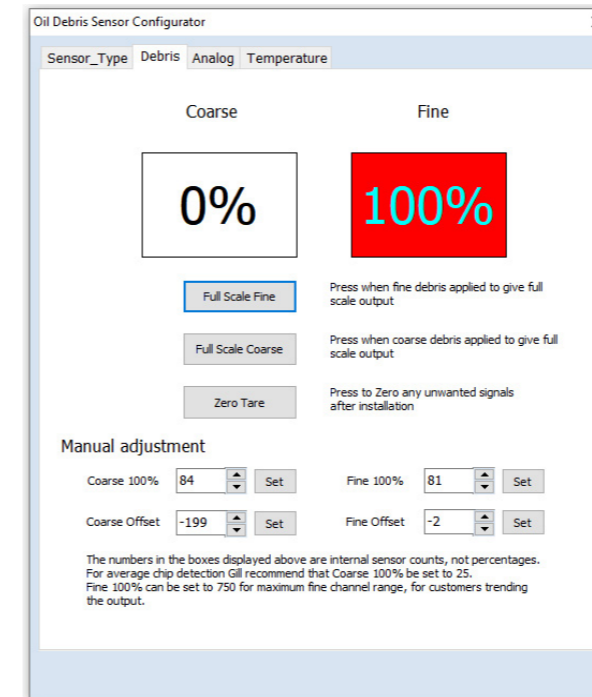

The sensor head is now calibrated and ready to fit to your equipment.

#### 4.2 Full Scale Coarse

The “full scale coarse” operation will gauge the output of the sensor to the desired level with the maximum amount of coarse debris applied to the sensor (100% Full Scale Deflection).

*Note: see Section 9 for the saturation point of coarse debris.*

Add some coarse debris to the sensor head (This should represent what you would constitute to a 100% failure). For this demonstration five 2mm balls were used.

The debris strip may also be used as reference.

For use with WearDetect Oil Debris Sensor and accessories

A coarse value will now be displayed in the window.

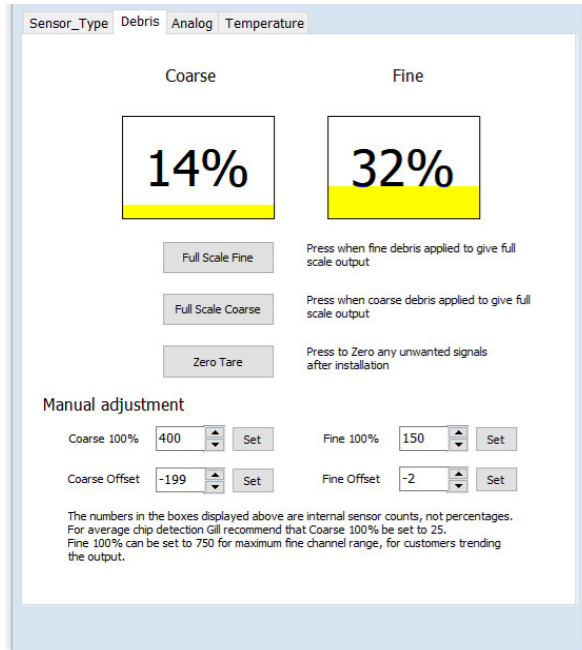

Press the "Full Scale Coarse" Button and this will set this quantity of debris as 100%.

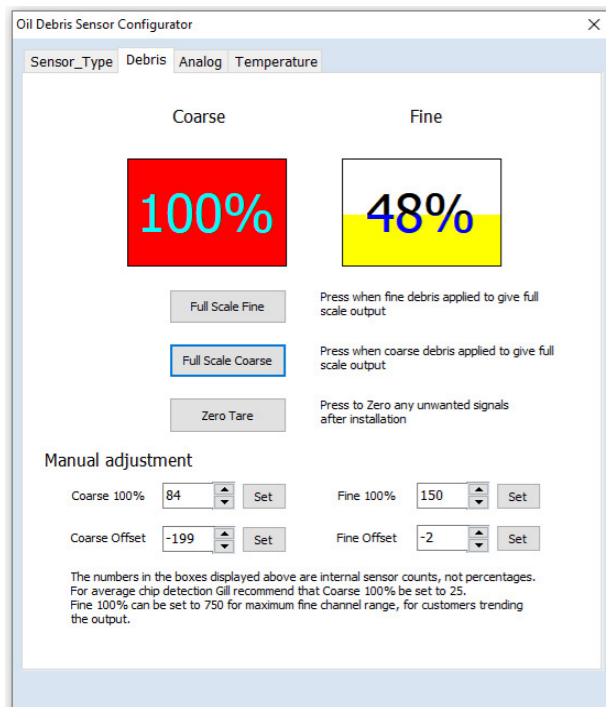

Note: that this is only a bulk indication. The sensor will not detect water content below 10%.

For use with WearDetect Oil Debris Sensor and accessories

### 4.3 Manual Adjustment

The "manual adjustment" function allows adjustments to the zero and full scale deflection of the fine and coarse channels. The up/down arrows can be used to bias the zero and full scale within the graphics window.

When the desired values are selected press the set button to write the value to the sensor.

Please note:

- Do not enter negative values for coarse and fine 100% as these would make the sensor operate in reverse, i.e. the less debris collected the greater the percentage displayed.
- If the value is too great then the setting is too insensitive and the percentage level displayed will be zero. Conversely, if the value is too low then the setting is too sensitive and the percentage level will be 100%, even if no debris is present.
- It is advisable to set both channels to 250 in the first instance.

### 4.4 Oil Calibration

Please note Oil dielectric measurement is not available where the sensor to be used has an NPT thread fitting.

WearDetect measures the dielectric property of the liquid surrounding the sensor element. This is used to provide information about dielectric changes such as a no-oil condition (air) or water in oil condition.

When a Water Contamination alarm threshold is reached, the sensor output is triggered to full scale. Normal Water Contamination remains at zero. When Water Contamination continuous is selected the sensor output will report a linear response between minimum and maximum values set in the configurator.

Select the Sensor pull down menu and then the Configure setting.

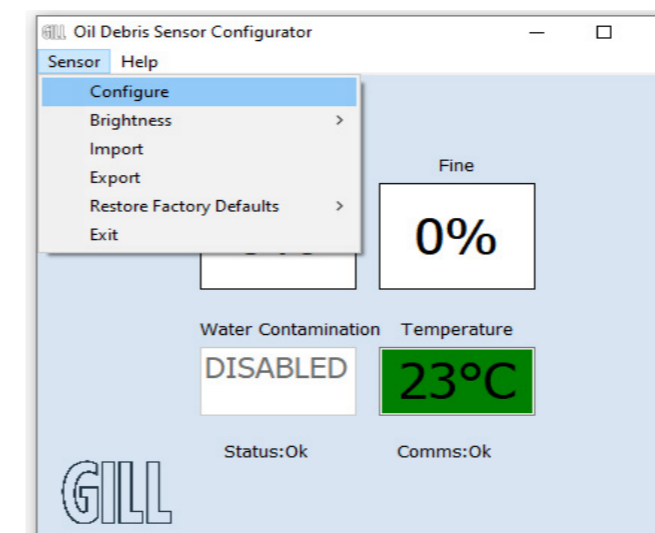

For use with WearDetect Oil Debris Sensor and accessories

Select the oil tab from this new window.

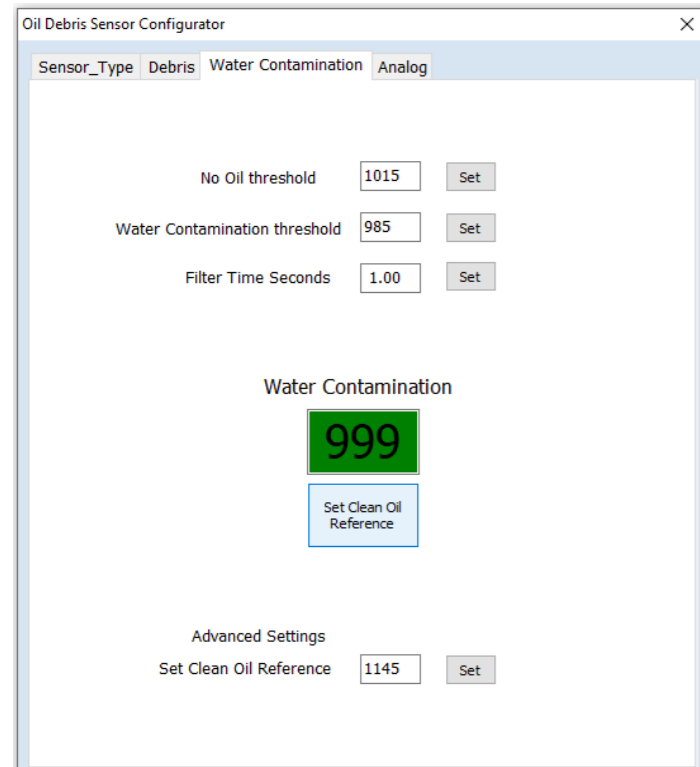

Fully immerse the sensor element in the selected reference oil (fresh oil) to set the Water Contamination reference value. The value should be normalised to 1000 once set.

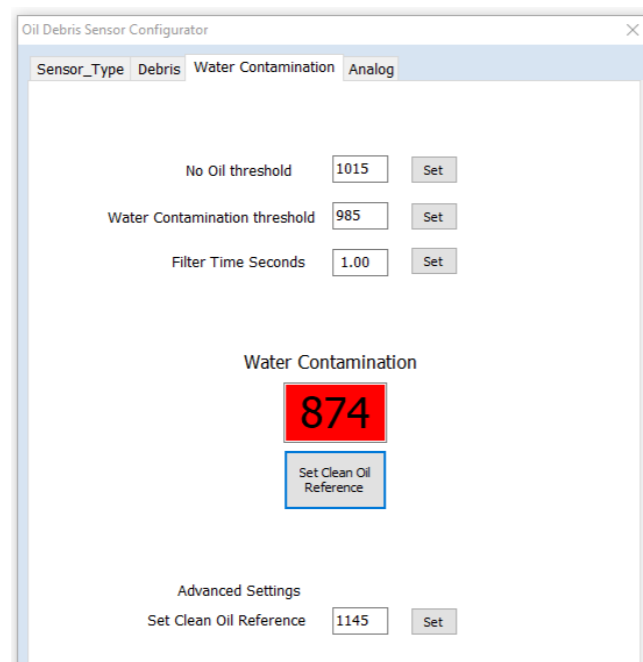

For use with WearDetect Oil Debris Sensor and accessories

Press the "Set Water Contamination Reference" button and this will return the value to 1000.

### Water Contamination

1000

Set Clean Oil Reference

Now remove the sensor head from the oil and set the "upper threshold" if needed. If the Water Contamination is not shown in red lower the threshold value just below the Water Contamination value and press the set button.

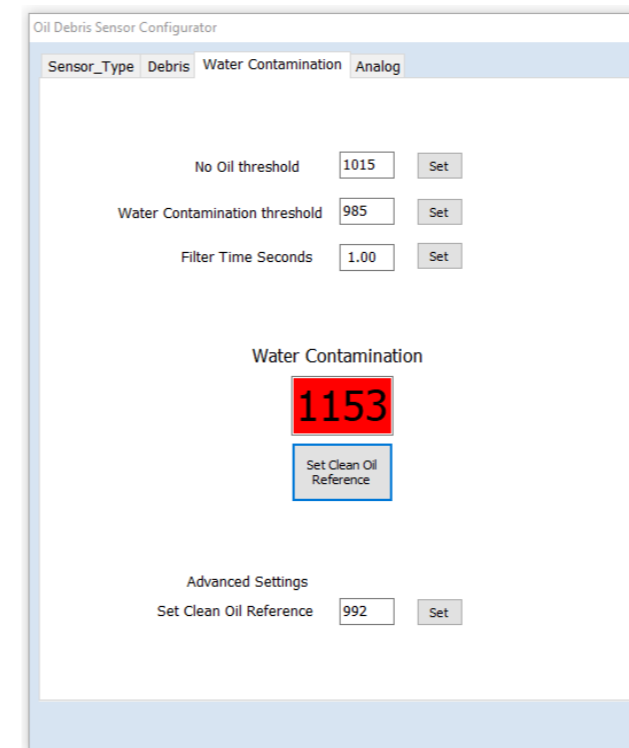

For use with WearDetect Oil Debris Sensor and accessories

Fully immerse the sensor element in an oil and water mix to set the "Water Contamination threshold". It should contain at least 10% water.

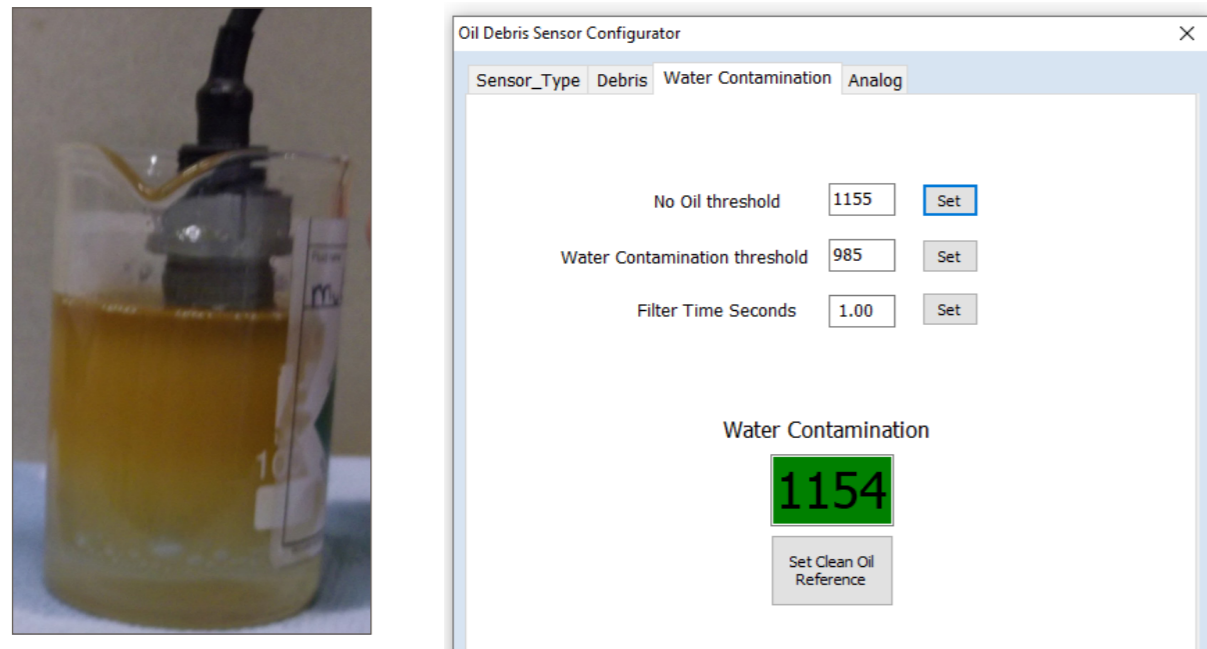

If the Water Contamination value is not shown in red, increase the value to just above the shown value and press set.

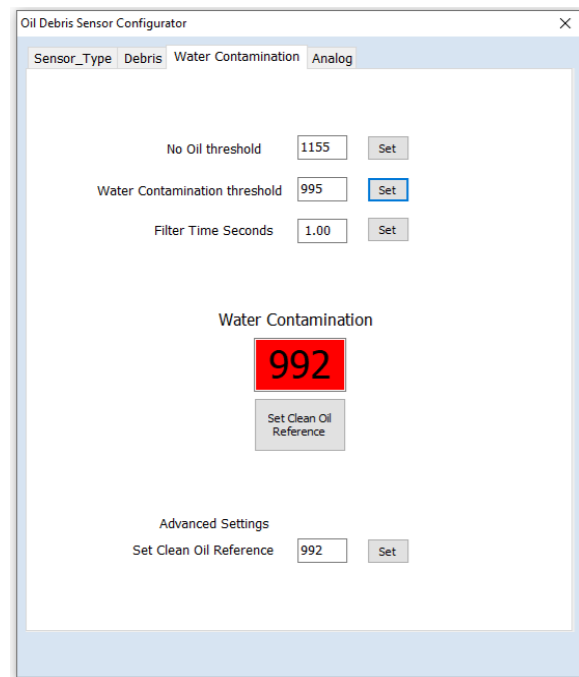

The sensor head is now calibrated and ready to fit to your equipment.

For use with WearDetect Oil Debris Sensor and accessories

### 4.4.1 Set Water Contamination Reference

Fully immerse the sensor element in the selected reference oil (fresh oil) to set the Water Contamination reference value. The Water Contamination window displays the reference value in real time. The value should be normalised to 1000 once set.

*Note: when the lower or upper alarm thresholds are reached the window changes status from green to red.*

### 4.4.2 No Oil Threshold

The "No oil threshold" is used to set the no-oil condition of the sensor.

To set the no oil threshold, remove the sensor element from the oil and note the new Water Contamination reference number with the sensor element positioned in free air. Enter the desired value into the "no oil threshold" dialogue box and press the set button to apply the new value.

*Note: the value should be set between the reference oil (1000) and the reference air value (>1000).*

### 4.4.3 Water Contamination Threshold

The "water contamination threshold" is used to set the end of life oil or water in oil condition of the sensor.

To set the water contamination threshold, place the sensor element in the end of life oil sample or water in oil sample and note the new Water Contamination reference number. Enter the desired value into the water contamination threshold dialogue box and press the set button to apply the new value.

### 4.4.4 Filter Time (seconds)

The "filter time" function is normally set to a 1 second sample period. The sample period may be extended to prevent false alarms in splash systems where the sensor element is not fully in contact with the oil.

### 4.4.5 Set Clean Oil Reference

The raw value for "set clean oil reference" is displayed in the set clean oil reference dialogue box. This can be manually adjusted to set the Water Contamination reference. See the appendix for guideline Water Contamination reference values for different oil types.

For use with WearDetect Oil Debris Sensor and accessories

### 4.5 Temperature

The temperature sensor measures the oil temperature at the sensor head. Either a high / low alarm can be set or continuous temperature can be reported.

Input the desired temperature values into the dialogue box and press the set button to write the value to the sensor.

See below for settings for high / low alarm.

High Temperature Alarm(C)

Low Temperature Alarm(C)

*Temperature alarm settings*

For a continuous temperature feed, set the range of temperature measurement as shown below.

High Temperature(C)

Low Temperature(C)

*Continuous temperature min / max settings*

### 4.6 Analog Output

For analogue output sensors, the following values can be set by the user:

#### 4.6.1 Error Level

The sensor output level at an error state may be set by the user to identify a sensor failure. Input the desired error level value into the dialogue box and press the set button to write the value to the sensor.

*Note: the error level is applied to all three output channels*

For use with WearDetect Oil Debris Sensor and accessories

#### 4.6.2 Zero level

The sensor output level may be set by the user to identify 0% FSD. Input the desired zero level (0%) value into the dialogue box and press the set button to write the value to the sensor.

*Note: The error level is applied to all three output channels*

#### 4.6.3 Full Scale Level

The sensor output level may be set by the user to identify 100% FSD. Input the desired full scale (100%) level value into the dialogue box and press the set button to write the value to the sensor.

*Note: The error level is applied to all three output channels*

#### 4.6.4 Inhibit Level

The sensor "inhibit level" may be set by the user to set the sensor output during maintenance and cleaning operations to a known state. Input the desired inhibit level value into the dialogue box and press the set button to write the value to the sensor.

### 4.7 CAN

*Note: For alternative CAN configurations consult Gill with your custom requirements*

For CAN output sensors, the following values are displayed:

#### 4.7.1 Function Instance

"Function instance" works in combination with the function field. A J1939 network may accommodate several ECUs (Controller Applications) with the same function. The 5 bit long function instance assigns a number to each instance of the function, where 0 is assigned to the first instance.

The function instance is factory set to 0000. Input the desired value into the dialogue box and press the set button to write the value to the sensor.

#### 4.7.2 ECU Instance

A J1939 network may accommodate several ECUs (controller applications) with the same function. The 3 bit long ECU instance assigns a number to each instance of the ECU, where 0 is assigned to the first instance.

"ECU instance" is factory set to 0000. Input the desired value into the dialogue box and press the set button to write the value to the sensor.

For use with WearDetect Oil Debris Sensor and accessories

### 4.7.3 Industry Group

Industry group codes are associated with particular industries. The 3 bit code is assigned by the SAE and definition can be found in the J1939 standard.

*"Industry group"* is factory set to 0000.

### 4.7.4 Vehicle System Instance

A J1939 network may accommodate several ECUs of the same vehicle system. The 4 bit long vehicle system instance assigns a number to each instance of the vehicle system (0 to 15).

*"Vehicle system instance"* is factory set to 0000.

### 4.7.5 Vehicle System

This 7 bit field is defined and assigned by the SAE. Definitions of the vehicle system are found in the J1939 standard.

*"Vehicle system"* instance is factory set to 0000.

### 4.7.6 Function

The function field is defined and assigned by the SAE. The range of the field is from 0 to 255. The function code does not depend on any other field in cases where it is less than 128 (0 to 127).

### 4.7.7 Manufacturer Code

The 11 bit Manufacturer code is assigned by the SAE and it indicates which manufacturer produced this particular equipment.

*"Manufacturer code"* is factory set to 07ff.

### 4.7.8 Identity Number

The identity number is assigned by the manufacturer and should be used to guarantee unique names within

*"Identity number"* is factory set to 0000.

### 4.7.9 NAME

For use with WearDetect Oil Debris Sensor and accessories

The 64 bit name is used to uniquely identify each equipment in a network. The *"NAME"* field contains 10 entries of which five are assigned by the SAE. The remaining five fields are derived from the network characteristics or are manufacturer specific.

The *"NAME"* field is also used during the claim process when two or more equipment's are attempting to claim the same address. In such a case the equipment with a name of higher priority (=lower numeric value) will claim the address.

### 4.8 PGN/ID

For CAN output sensors, the following values are displayed:

#### 4.8.1 Priority

There are 8 priority levels which represent the equipment priority during the arbitration process. In compliance with the CAN standard a value of 0 has the highest priority and a value of 8 has the lowest priority.

*"Priority number"* is factory set to 0006.

#### 4.8.2 Data Page

ata page bit works as a page selector for the protocol data unit.

*"Data page"* is factory set to 0001.

#### 4.8.3 PDU Format

The protocol data unit defines the function of the PDU specific. A value of 240 to 255 is a destination address broadcast message. A value between 0 – 239 is a group extension peer-to-peer message.

The PDU format is factory set to 00ff.

#### 4.8.4 PDU Specific

PDU specific means that its content is interpreted according to the information in the PDU format. A value 240 to 255 is a destination address broadcast message. A value between 0 – 239 is a group extension peer-to-peer message.

For use with WearDetect Oil Debris Sensor and accessories

*"PDU specific"* is factory set to 0000.

The last 8 bits of the message identifier contains the address of the transmitting equipment. There is a total of 253 addresses available and every address must be unique within the network.

Input the desired value into the dialogue box and press the set button to write the value to the sensor.

### 4.8.5 PGN

The parameter group number (PGN) uniquely identifies the parameter group that is being transmitted in the message. The structure of the PGN permits a total of up to 8672 different parameter groups to be defined.

The PGN is compiled from the assignment of each parameter.

### 4.8.6 CAN ID

The CAN ID is displayed in this window.

For use with WearDetect Oil Debris Sensor and accessories

## 5.0 Miscellaneous settings

### 5.1 LED Brightness (Sensors with display Only)

To make adjustments to the LED brightness:

Select the Sensor>Brightness option from the top pull down menu and select the desired LED brightness.

### 5.2 Exporting a Configuration File

When your WearDetect Oil Debris Sensor is fully configured it is recommended that the configuration is saved for future reference. The configuration file contains all of the user configurable information. Follow the steps below to import and export a configuration file.

Select the Sensor>Export option from the top pull down menu.

Enter the file name and save the file (\*.dsc) to a suitable location on your PC.

### 5.3 Importing a Configuration File

To setup your sensor with a pre-saved configuration file use the following steps to import the pre-configured settings:

Select the Sensor>Import option from the top pull down menu.

Navigate and select the required configuration file (\*.dsc) and press the open button. The new configuration file will be automatically loaded.

### 5.4 Restore Factory Defaults

The following factory defaults are loaded into the sensor and can be restored at any time during sensor configuration. The sensor is shipped with the measurement scale set to small. The default configuration settings are defined below:



For use with WearDetect Oil Debris Sensor and accessories

Parameter	Sensitivity Scale	
	Small	
Water Contamination	Reference Oil Type	Mineral Oil
	No Oil Threshold	1010
	Water Contamination Threshold	985
	Filter Time	1 Second
Temperature Status	High Temperature Alarm	+150 °C
	Low Temperature Alarm	-26 °C
LED Brightness (Sensor with display models only)	Maximum	
0-10V Outputs	Error Level	0.0V
	0% FSD	2V
	100% FSD	10V
	Inhibit	1V
4-20 mA Outputs	Error Level	0 mA
	0% FSD	4 mA
	100% FSD	20 mA
	Inhibit	2 mA
Can Outputs (J1939)	Function instance	User Configured
	ECU Instance	User Configured
	Industry Group	0000
Can Outputs (J1939)	Vehicle System Instance	0000
	Vehicle System	0000
	Function	00ff
	Manufacturer Code	07ff
	Identity Number	0000
	NAME	User Configured
PGN/ID	Priority	0006
	Data Page	0001
	PDU Format	00ff
	PDU Specific	0000
	Address	User Configured
	PGN	User Configured
	CAN ID	User Configured

For use with WearDetect Oil Debris Sensor and accessories

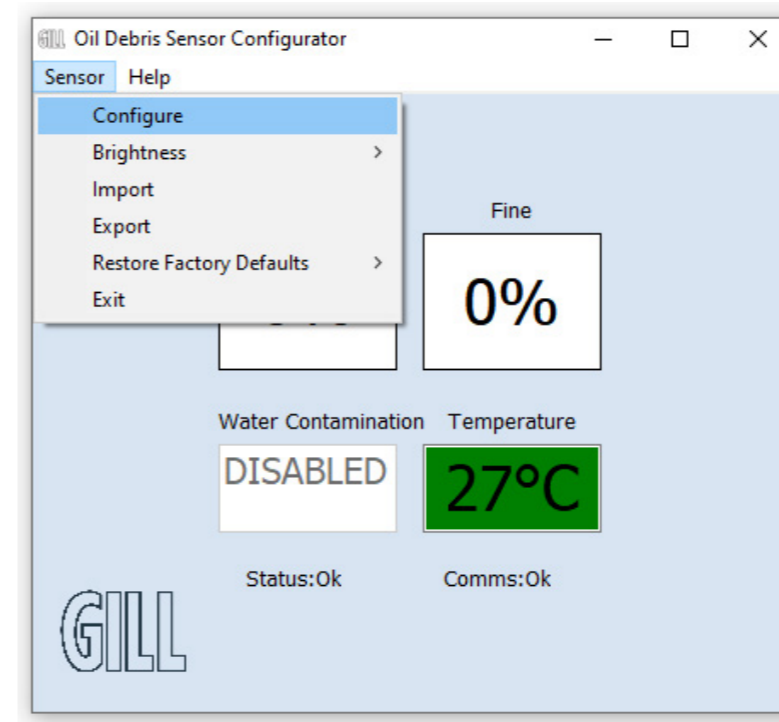

Select 'Restore Factory Defaults' then 'Small' then 'Yes'. On the next screen select 'zero/tare'.

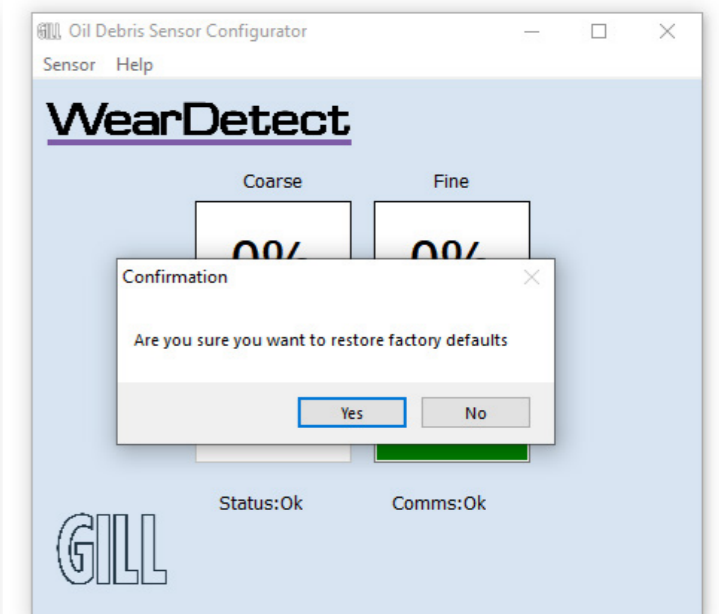
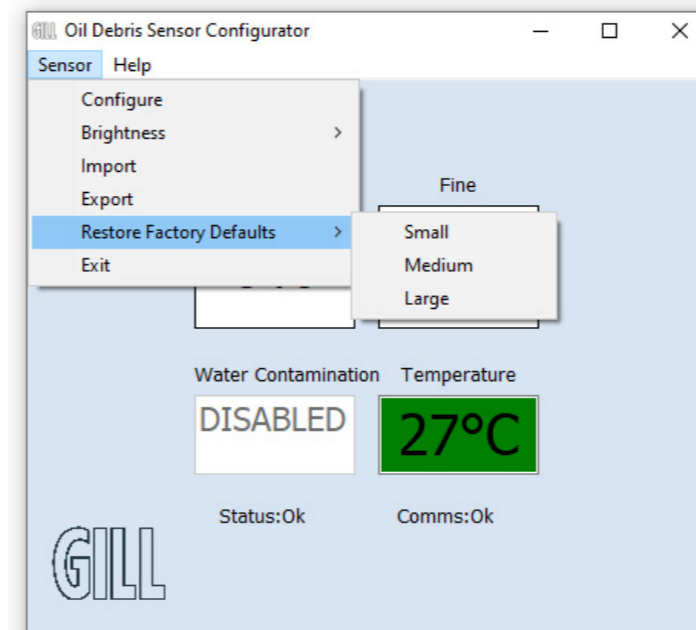

For use with WearDetect Oil Debris Sensor and accessories

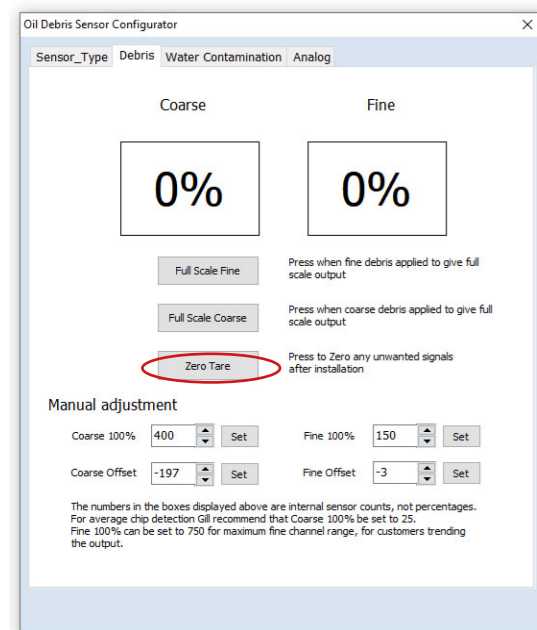

*Note: It is recommended that the zero/tare and Water Contamination reference is always re-set after the factory defaults are loaded.*

*Note: On completion of configuration, remove the cable assembly and re-assemble the lid ensuring any sealing gasket is correctly located and the screws are fully tightened to 4Nm +/-0.4Nm during re-assembly.*

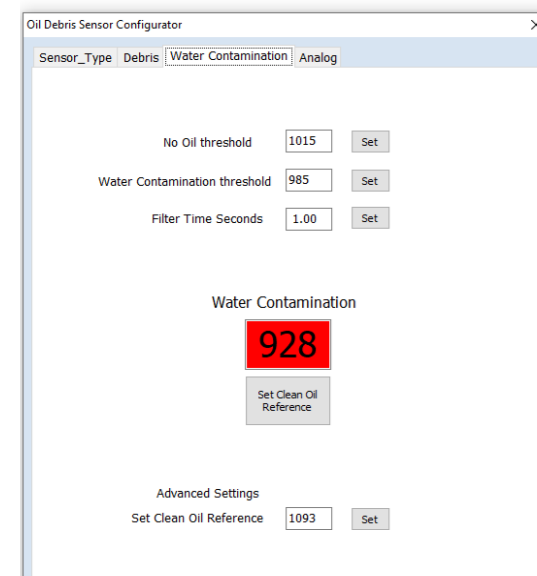

Select 'Set Water Contamination Reference' and the Water Contamination window will return to green.

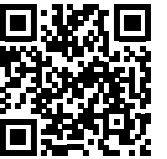

For use with WearDetect Oil Debris Sensor and accessories

## 6. Installation

*Safety Warning: This equipment is not ATEX certified and has not been designed for use in areas which fall within the scope of the ATEX directive. If the area of intended usage is within the scope of the ATEX directive, then contact Gill Sensors & Controls Limited for further information*

WearDetect consists of two parts, the sensor head and its electronics and a separately supplied fitting adaptor to enable the sensor to fit a wide range of thread types.

### 6.1 Sensor Location

All models in the range should be installed in the within the lubricating circuit of the equipment to be monitored. The sensor head can either be installed as a sump plug replacement or within a piped oil circuit often used as a filter bypass. In this instance Gill offer a special Inflow installation kit to allow this type of installation. Please see section 6.3 for more details on this installation type.

Whether installed directly on the equipment or using the Inflow system, it is recommended that the sensor head is installed directly in the flow of oil, before any particle filtration devices to maximise ferrous particle capture. In addition, the sensor head may be located at the bottom of an oil pump or reservoir to collect particles that have settled. When installing into a stainless steel fitting, Gill recommend using anti-sieze compound.

For oil contamination applications, the optimum sensor position is at the bottom of the sump for non-miscible oils or for miscible oils the sensor may be mounted in any position providing the 12mm oil sensing region remains in permanent contact with the oil. (Not applicable where the NPT thread adaptor is fitted).

For oil loss indication the sensor may be mounted in any orientation. The no oil condition is achieved when the 12mm oil sensor region is no longer in contact with the oil. (Not applicable where the NPT thread adaptor is fitted).

### 6.2 Sensor Head

WearDetect Oil Debris Sensor consists of two parts, the sensor head and its electronics and a separately supplied fitting adaptor to enable the sensor to fit a wide range of thread types.



For use with WearDetect Oil Debris Sensor and accessories

First check the sensor and all associated parts are present and undamaged before installation, informing your supplier of any issues.

Fit up to three grub screws into the adaptor without tightening them home.

*Note: When installing in environments of high vibration, threadlock (Loctite 270 or similar) can be applied to the grub screws at this stage. This will provide a permanent connection between the sensor head and the adaptor if threadlock is used.*

Fit the Thread Adaptor to the equipment. Ensure that the supplied sealing washer is fitted or use a suitable thread sealant for NPT adaptors. After hand tightening as far as possible, fully tighten to 50Nm using the correct spanner. (please refer to the fitting chart in section 6.4)

Carefully fit the Sensor Probe into the Thread Adaptor: There may be some resistance as the probe pushes past the internal o-ring seals. When the sensor is fully home it will hit a stop and the rear surfaces of the 2 parts will be at the same level. Secure the 2 parts together by tightening the grub screws using a 2mm hex key to a torque of 1Nm.



Restrain the cable to the equipment or similar structure in a safe manner such that it is not subject to undue wear or damage whilst the equipment is in use.

*Note: It is also acceptable to install the sensor probe into the thread adaptor first, and then screw the complete assembly into the equipment as described above (Note: if using this method take care to not twist the cable excessively.)*

*Note: Each sensor is supplied with 3m of sensor head cabling which should not be altered on models without the display. However, models with the display can be shortened and re-attached to the screw terminal connections within the display electronics enclosure. Gill recommend using the supplied bootlace ferrules for crimping and terminating to the terminal block.*

*Note: Gill recommend cable lengths are kept to a minimum to prevent voltage drops that may occur as a result affecting the operation of the sensor. Particular care should be made to J1939 CAN variants to ensure electrical characteristics of the CAN bus are not compromised.*

For use with WearDetect Oil Debris Sensor and accessories

### 6.3 Sensor Electronics

Having fitted the sensor to the equipment, secure the electronics enclosure in a position where vibration is minimised but where it can be accessed, and in the case of the display models, where the display is visible.

#### 6.3.1 Sensors with display

Two diameter 6.4mm mounting holes are provided for fixing the sensor electronics to a fixed surface. The mounting holes are accessed by removal of the lid. The fixings (not provided) shall be suitable for supporting the weight of the enclosure. The following figure shows the mounting dimensions:

Connect the sensor electronics according to the guidance in section 2, covering power and output connections.

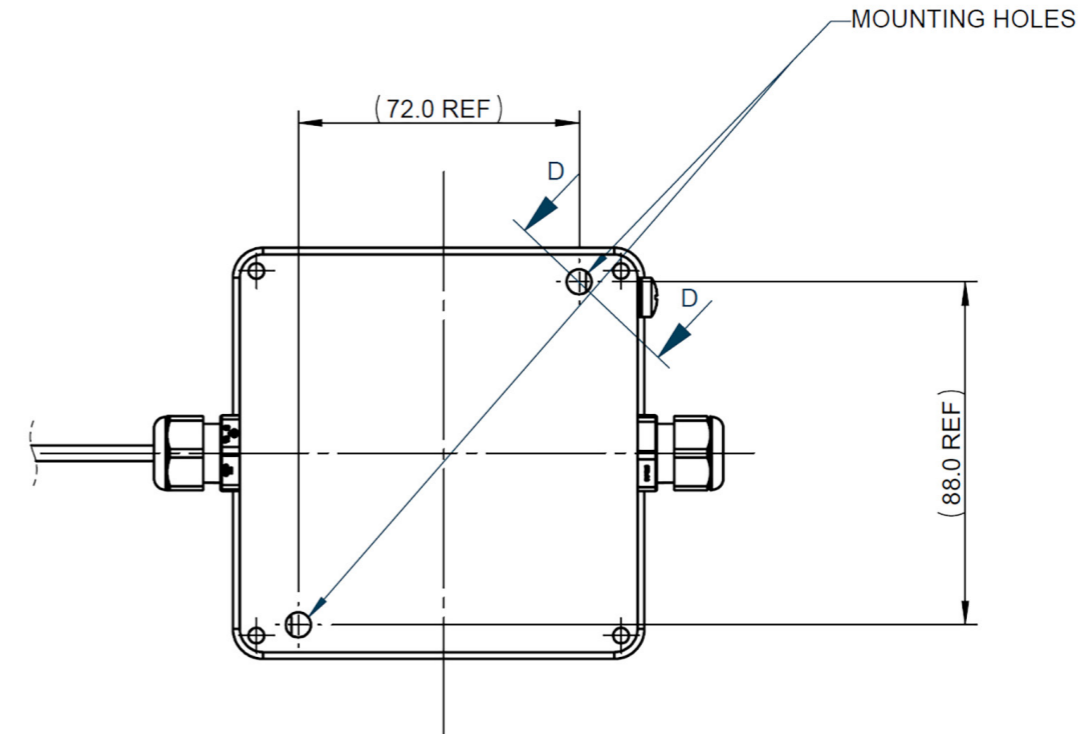

#### 6.3.2 Sensors without display Electronics Mounting

Two 4.2mm diameter mounting slots are provided for fixing the electronics enclosure to a fixed surface. The fixings must be suitable for supporting the weight of the enclosure. The following figure shows the mounting dimensions:

For use with WearDetect Oil Debris Sensor and accessories

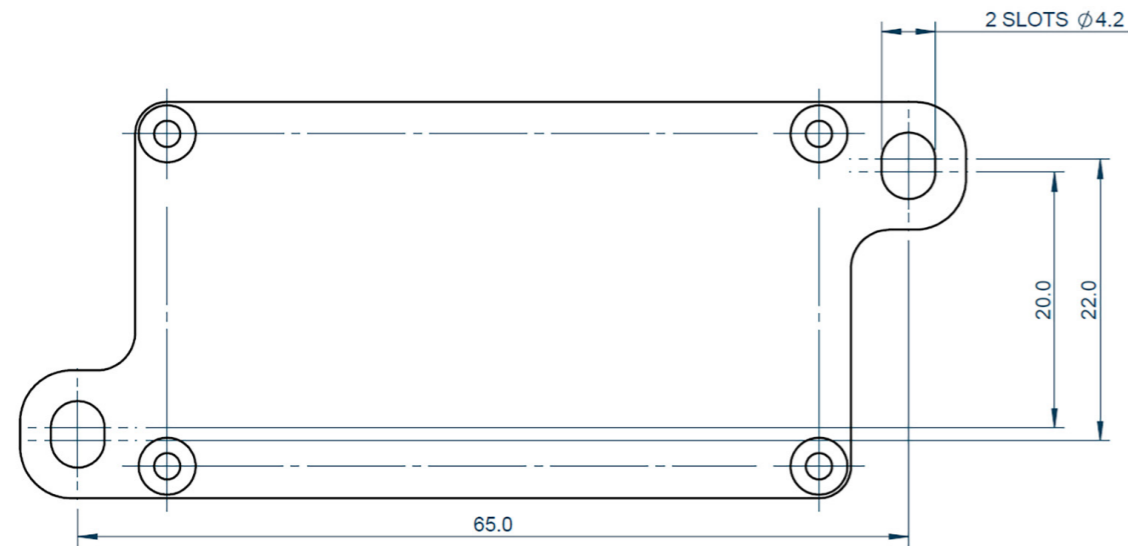

### 6.3.3 Grounding the Enclosure

The Oil Debris Sensor complies with International EMC standards. In order to maintain compliance with these standards it is essential the electrical installation is connected to ground correctly. Please consult section 9.5 for guidance ensuring the installation complies with local laws and regulations. It is the installers' responsibility to ensure the installation meets relevant local requirements.

The following local safety earth is provided for grounding the Sensor with display models (4212i) metal enclosure when required.

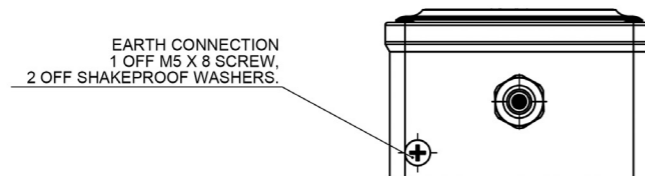

### 6.4 Cabling

Cable strain relief has been provided where cables enter both the sensor head and electronics enclosures. Please take care not to stress the cables at the cable entries, observing a minimum bend radius of 20mm for all cables.

*Note; On units with display electronics through cable glands suited to cables between 2 – 6mm diameter. When installing this unit, please ensure glands are fully tightened to maintain the strain relief and ingress protection for the unit.*

If Adaptor and sensor are installed as a complete assembly Gill recommend allowing for 3 turns of the cable at the sensor head when first installing the sensor. This avoids unnecessary coiling of the cable when

For use with WearDetect Oil Debris Sensor and accessories

removing and refitting the sensor head.

The Sensor probe is able to rotate slowly within the Thread adaptor body. Carefully holding the sensor while (un)tightening the adaptor can also avoid cable twist

### 6.4.1 Cable Protection: Sensors with display models

An optional conduit kit (Gill part No. 4212-10-051-X) is offered for additional cable protection for the Sensor with display models. For installation, follow the guidance below:

- Fit conduit before sensor is fitted to the thread adaptor
- Remove your Oil Debris Sensor from the Sensor with display electronics enclosure, disconnecting the wiring from the termination block.
- Remove the M16 cable gland from the sensor by unscrewing the M16 back nut.
- Install the female adaptor onto the back of the sensor head, using an appropriate thread sealer to maintain the ingress protection of the enclosure.
- Cut the conduit tube to the required length, feed the sensor head cable through the conduit tube and clip into the back of the female adaptor by firmly pushing the tube into the aperture.
- Feed the cable through the male adaptor and clip into the back of the adaptor by firmly pushing the tube into the aperture.
- Install the sensor into the gearbox, engine or pump housing ensuring that the sealing washer is used.
- Fit the male adaptor into the enclosure by securely fastening the back nut ensuring that the sealing washer is used.

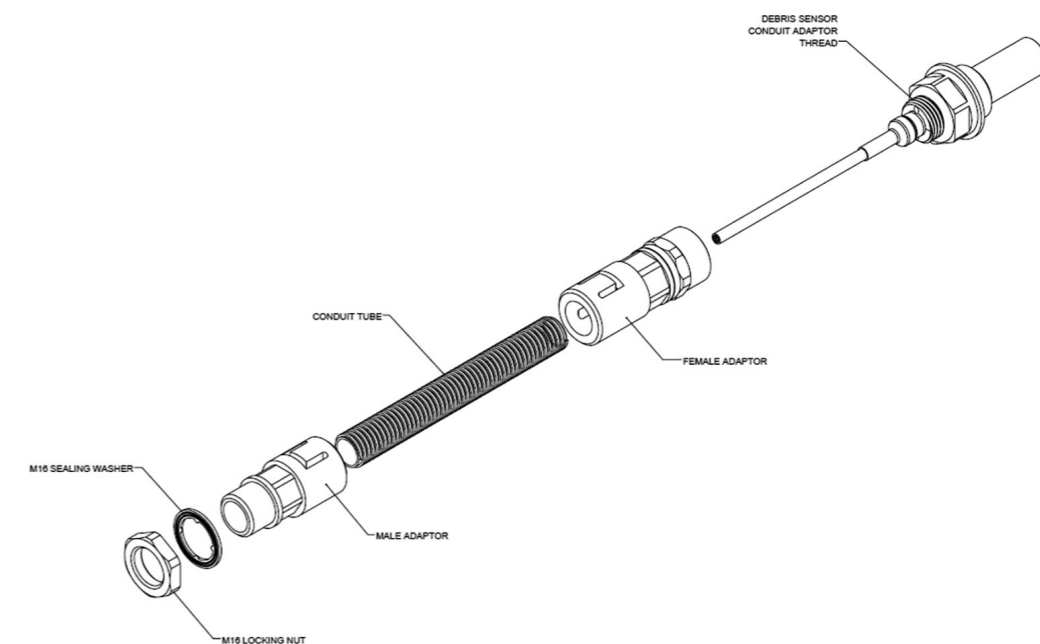

For use with WearDetect Oil Debris Sensor and accessories

### 6.5 Sensor Head Fitting Chart

The following are the spanner sizes and tightening torques applicable for each mounting thread option:

Thread Size	Spanner A/F	Torque $\pm 10\%$
M22 X 1.5	36.0	50Nm
M24 X 2.0	36.0	50Nm
3/4" X 16 UNF	36.0	50Nm
1/2" BSPP	36.0	50Nm
M20 X 1.5	36.0	50Nm
1/2" NPT	36.0	Refer to ANSI/ ASME B.20.1 for guidance
3/4" NPT	36.0	
1" NPT	36.0	
1 1/4" NPT	36.0	
1 1/2" NPT	36.0	

For guidance on installing the sensor within a piped oil system using the Inflow models please refer to the installation guidance provided with the product.

For use with WearDetect Oil Debris Sensor and accessories

### 6.6 Inflow Sensor Head Fitting (Optional)

Gill have developed a special installation fitting to allow sensor head mounting into an oil bypass circuit. Designed to fit standard industrial BSP pipe fittings, either the 4212-00-160-100 1" or 4212-160-150 1.5" kit provide all items necessary to fit a sensor to a bypass circuit including special M20 x 1.5 sensor head mount, isolation valves and brackets. The following images illustrate the kits and their pipe compatibility.

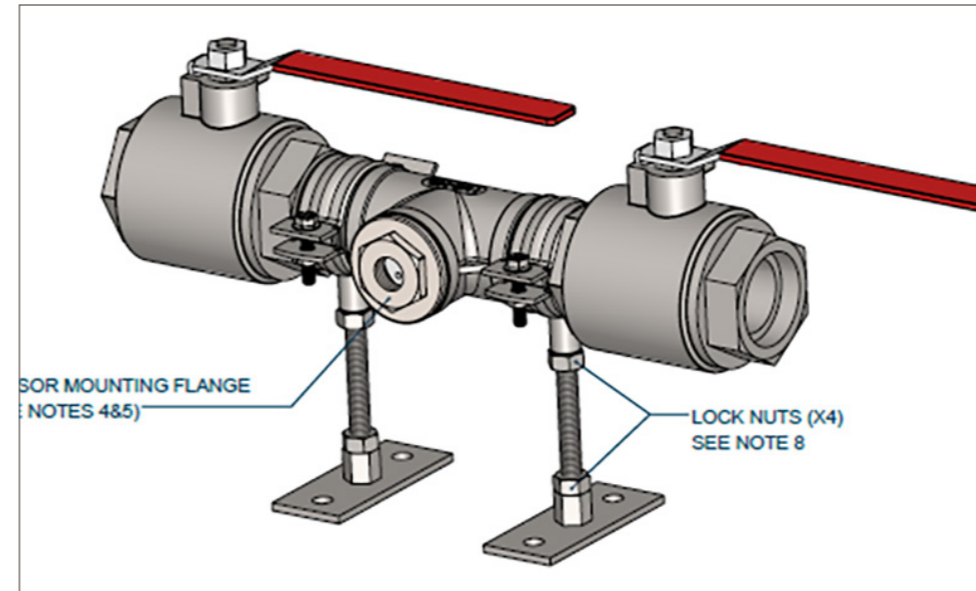

Compatibility	4212-00-160-150	4212-00-160-100
	Inflow Oil Debris Kit 1.5"	Inflow OilCondition Kit 1.0"
Oil Debris Sensor with Display	✓	✓
Oil Debris Sensor without Display	✓	✓
BSP 1.5" Hose tail	✓	X
BSP 1.25" Hose tail	✓	X
BSP 1" Hose tail	X	✓
BSP 0.75" Hose tail	X	✓
BSP 0.5" Hose tail	X	✓
BSP 0.375" Hose tail	X	✓
BSP 0.25" Hose tail	X	✓

# WearDetect

## Oil Debris Sensor

For use with WearDetect Oil Debris Sensor and accessories

As illustrated below, the sensor should be positioned horizontally within the oil flow to enable collection of the debris without flow restriction. Isolation valves are supplied to facilitate easy cleaning and maintenance without full system drain-down

In addition, Gill can offer the sensor mount separately where isolation valves and associated hardware is not

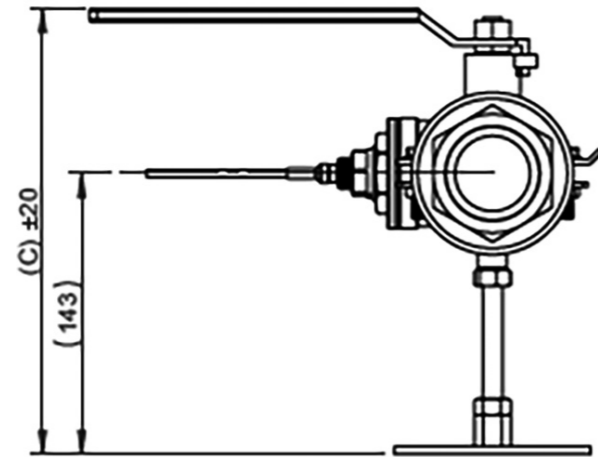

needed. This is a 1.5" diameter BSP fitting and allows connection to smaller pipe sizes with additional pipe size reducers (not supplied).

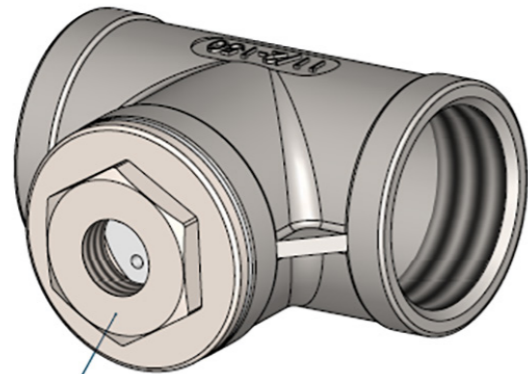

SENSOR MOUNTING FLANGE  
SEE NOTES 1&3)

Note: In all cases use of the Inflow kit requires the sensor to have the M20 x 1.5 adaptor (the 4212-PK-502 option from list of adaptor options).

For further guidance on installing the sensor within a piped oil system using the Inflow models, please refer to the guidance supplied with the product.

# WearDetect

## Oil Debris Sensor

For use with WearDetect Oil Debris Sensor and accessories

### 7. Specifications

#### 7.1 Sensors with display: 4 – 20 mA output

Model Number: 4212-PK-145 Sensor Connections*	
Shield	Silver/Clear Wire
Debris measure	Red
Debris Ref	Blue
Oil Signal	Green
Oil Ref	White
Temp	Orange
Sensor head GND	Black
Wire	26 AWG PTFE 3G210 screened with DR25 jacket

Note: Connect the wires from the sensor head to the respective terminals in the electronics enclosure, see section 2.3

Electrical Enclosure		Connections and outputs	
Supply voltage	+9 V to +26 V DC	SHIELD	-
Over-voltage protection	> 32 V DC	CAN H	Not connected
Power consumption	< 5.6 Watts	CAN L	Not connected
Reverse polarity protection	> -32 V	Power DC +ve	+9 to +26 V DC
Resolution	10-bit	Power DC -ve (ground)	0 V DC
Report update rate	10 Hz	OIL/TEMP	0 to 20 mA
Configuration interface	Micro USB	FINE	0 to 20 mA
		COARSE	0 to 20 mA
		Error indication	All outputs, 0 – 20 mA
		Output inhibit*	All outputs, 0 – 20 mA
		Multicolour light ring**	All outputs
		Wire range***	35 to 13 AWG (solid)
			35 to 15 AWG (stranded)
		Armour	Additional option

\* The output inhibit is the voltage output when configuring the sensor.

\*\* For the function of the multicolour light ring see section below.

\*\*\* Bootlace ferrules are provided protect the wires from damage by the screw terminals.

# WearDetect

## Oil Debris Sensor

For use with WearDetect Oil Debris Sensor and accessories



Green - OK

Amber - increase with debris collection

Red (Flashing) - Maximum debris condition breached

Mechanical		
Sensor	Enclosure	
Size	57 mm x ø24.5mm	105.5 mm (w) x 105.5 mm (l) x 66 mm (h)
Mounting	Threaded	2 off M6 socket-cap screws (not supplied)
Materials	Stainless steel, FEP, PEI	Al. alloy, Stainless steel, polyester
Weight	0.7 kg in total	

### 7.2 Sensors with display: 0-10V Voltage output

Model Number: 4212-PK-146

Model Number: 4212-PK-146 Sensor Connections*	
Shield	Silver/Clear Wire
Debris measure	Red
Debris Ref	Blue
Oil Signal	Green
Oil Ref	White
Temp	Orange
Sensor head GND	Black
Wire	26 AWG PTFE 3G210 screened with DR25 jacket

Connect the wires from the sensor head to the respective terminals in the electronics box. See section 7.4

# WearDetect

## Oil Debris Sensor

For use with WearDetect Oil Debris Sensor and accessories

Electrical Enclosure		Connections and outputs	
Supply voltage	+5 V to +32 V DC	SRed wire	Power DC +ve
Over-voltage protection	> 32 V DC	Black wire	Power DC -ve (ground)
Power consumption	< 0.7 Watts	White wire , 0 – 10 V	Fine debris
Reverse polarity protection	> -32 V	Green wire , 0 – 10 V	Coarse debris
Resolution	10-bit	Orange wire , 0 – 10 V	Oil or temperature
Report update rate	10 Hz	Blue wire Blue wire	Blue wire
Configuration interface	Micro USB	Silver/clear wire	Screen
		All outputs , 0 – 10 V	Error indication
		All outputs , 0 – 10 V	Output inhibit**
Wire	26 AWG PTFE 3G210 screened with DR25 jacket		

\* The supply voltage must be greater than the configured output voltage; for a 5 V output the supply must be greater than 5 V.

\*\* The output inhibit is the voltage output when configuring the sensor

\*\*\* For the function of the multicolour light ring see section below.

\*\*\*\* Bootlace ferrules are provided to fit the connector.



Green - OK

Amber - increase with debris collection

Red (Flashing) - Maximum debris condition breached

Mechanical		
	Sensor	Enclosure
Size	57 mm x ø24.5mm	105.5 mm (w) x 105.5 mm (l) x 66 mm (h)
Mounting	Threaded	2 off M6 socket-cap screws (not supplied)
Materials	Stainless steel, FEP, PEI	Al. alloy, st/steel, polyester
Weight	0.7 kg in total	

# WearDetect

## Oil Debris Sensor

For use with WearDetect Oil Debris Sensor and accessories

### 7.3 Sensors with display: J1939 CAN output

Model Number: 4212-PK-147

Model Number: 4212-PK-147 Sensor Connections*	
Shield	Silver/Clear Wire
Debris measure	Red
Debris Ref	Blue
Oil Signal	Green
Oil Ref	White
Temp	Orange
Sensor head GND	Black
Wire	26 AWG PTFE 3G210 screened with DR25 jacket

Connect the wires from the sensor head to the respective terminals in the electronics enclosure, see section 2.3

Electrical Enclosure		Connections and outputs	
Supply voltage	+5 V to +26 V DC	SHIELD	-
Over-voltage protection	> 32 V DC	CAN H	CAN H (not terminated)
Power consumption	< 2.8 Watts	CAN L	CAN L (not terminated)
Reverse polarity protection	> -32 V	Power DC +ve	+5 to +26 V DC
Resolution	7-bit	Power DC -ve (ground)	0 V DC
Report update rate	1 Hz	OIL/TEMP	No connection
Configuration interface	Micro USB	FINE	No connection
		COARSE	No connection
		Multicolour light ring**	All outputs
		Wire range***	35 to 13 AWG (solid)
			35 to 15 AWG (stranded)
		Armour	Additional option

\* For the function of the multicolour light ring see section below.

\*\* Bootlace ferrules are provided to fit the connector.



Green - OK

Amber - increase with debris collection

Red (Flashing) - Maximum debris condition breached

# WearDetect

## Oil Debris Sensor

For use with WearDetect Oil Debris Sensor and accessories

Mechanical		
Sensor		Enclosure
Size	57 mm x ø24.5mm	105.5 mm (w) x 105.5 mm (l) x 66 mm (h)
Mounting	Threaded	2 off M6 socket-cap screws (not supplied)
Materials	Stainless steel, FEP, PEI	Al. alloy, st/steel, polyester
Weight	0.7 kg in total	

Electrical Enclosure		Connections and outputs	
Standard	J1939	Byte 0	Coarse measurement 0 to 100%, no scaling
Approval	Compatible	Byte 1	Fine measurement 0 to 100%, no scaling
Data Length	8 bytes	Byte 2	8 x Status bits*
PGN	130816	Byte 3	(Mux) Multiplex of next 5 bytes**
Report rate	1 Hz	Byte 4	}
Can bit rate	250 kb/s	Byte 5	} Meaning depends on value of Byte 3**
		Byte 6	}
		Byte 7	}

\*

Status bits are:  
*b0 – temperature alarm,  
 b1 – oil dielectric too high  
 b2 – oil dielectric too low,  
 b3 – fine debris error,  
 b4 – coarse debris error  
 b5 – dielectric error,  
 b6 – internal temperature error,  
 b7 – external temperature error.*

\*\*

*Byte 3 values 0x00 to 0x08: bytes 4 to 7 are manufacturer specific  
 Byte 3 value 0x09: bytes 6 and 7 are sensor head temperature as 0.0625 °C / bit  
 Byte 3 value 0x0A: bytes 6 and 7 are electronics temperature as 0.0625 °C / bit*



For use with WearDetect Oil Debris Sensor and accessories

### 7.4 Sensors without display: 4 – 20 mA output

Model Number: 4212-PK-148

Electrical Enclosure		Connections and outputs	
Supply voltage	+9 V to +32 V DC	Red wire	Power DC +ve
Over-voltage protection	> 32 V DC	Black wire	Power DC –ve (ground)
Power consumption	< 2.6 Watts	White wire , 4 - 20 mA	Fine debris
Reverse polarity protection	> -32 V	Green wire , 4 - 20 mA	Coarse debris
Resolution	10-bit	Orange wire , 4 - 20 mA	Oil or temperature
Report update rate	10 Hz	Blue wire Blue wire	Blue wire
Configuration interface	Micro USB	Silver/clear wire	Screen
		All outputs , 4 - 20 mA	Error indication
		All outputs , 4 - 20 mA	Output inhibit*

\* The output inhibit is the current output when configuring the sensor

Note: All 4-20mA channels can be configured between 0mA and 20mA with the Gill Oil Debris Sensor user interface.

Mechanical		
	Sensor	Enclosure
Size	57 mm x ø24.5mm	55 mm (w) x 30 mm (l) x 12 mm (h)
Mounting	Threaded	2 off M4 screws (not supplied)
Materials	Stainless steel, FEP, PEI	Al. alloy, st/steel, polyester
Weight	0.21 kg in total	

### 7.5 Sensors without display: 0-10V Voltage output

Model Number: 4212-PK-149

Electrical Enclosure		Connections and outputs	
Supply voltage	+5 V to +32 V DC	SRed wire	Power DC +ve
Over-voltage protection	> 32 V DC	Black wire	Power DC –ve (ground)
Power consumption	< 0.7 Watts	White wire , 0 – 10 V	Fine debris
Reverse polarity protection	> -32 V	Green wire , 0 – 10 V	Coarse debris
Resolution	10-bit	Orange wire , 0 – 10 V	Oil or temperature
Report update rate	10 Hz	Blue wire Blue wire	Blue wire
Configuration interface	Micro USB	Silver/clear wire	Screen
		All outputs , 0 – 10 V	Error indication
		All outputs , 0 – 10 V	Output inhibit**
Wire	26 AWG PTFE 3G210 screened with DR25 jacket		

For use with WearDetect Oil Debris Sensor and accessories

\* The supply voltage must be greater than the configured output voltage; for a 5 V output the supply must be greater than 5 V.

\*\* The output inhibit is the voltage output when configuring the sensor

Mechanical		
	Sensor	Enclosure
Size	57 mm x ø24.5mm	55 mm (w) x 30 mm (l) x 12 mm (h)
Mounting	Threaded	2 off M4 screws (not supplied)
Materials	Stainless steel, FEP, PEI	Al. alloy, st/steel, polyester
Weight	0.21 kg in total	

### 7.6 Sensors without display: J1939 CAN output

Model Number: 4212-PK-150

Electrical Enclosure		Connections and outputs	
Supply voltage	+5 V to +26 V DC	SHIELD	-
Over-voltage protection	> 32 V DC	CAN H	CAN H (not terminated)
Power consumption	< 2.8 Watts	CAN L	CAN L (not terminated)
Reverse polarity protection	> -32 V	Power DC +ve	+5 to +26 V DC
Resolution	7-bit	Power DC –ve (ground)	0 V DC
Report update rate	1 Hz	OIL/TEMP	No connection
Configuration interface	Micro USB	FINE	No connection
		COARSE	No connection
		Multicolour light ring**	All outputs
		Wire range***	35 to 13 AWG (solid)
			35 to 15 AWG (stranded)
		Armour	Additional option

Mechanical		
	Sensor	Enclosure
Size	57 mm x ø24.5mm	55 mm (w) x 30 mm (l) x 12 mm (h)
Mounting	Threaded	2 off M4 screws (not supplied)
Materials	Stainless steel, FEP, PEI	Al. alloy, st/steel, polyester
Weight	0.21 kg in total	

For use with WearDetect Oil Debris Sensor and accessories

Electrical Enclosure		Connections and outputs	
Standard	J1939	Byte 0	Coarse measurement 0 to 100%, no scaling
Approval	Compatible	Byte 1	Fine measurement 0 to 100%, no scaling
Data Length	8 bytes	Byte 2	8 x Status bits*
PGN	130816	Byte 3	(Mux) Multiplex of next 5 bytes**
Report rate	1 Hz	Byte 4	}
Can bit rate	250 kb/s	Byte 5	} Meaning depends on value of Byte 3**
		Byte 6	}
		Byte 7	}

\*

Status bits are:  
*b0* – temperature alarm,  
*b1* – oil dielectric too high  
*b2* – oil dielectric too low,  
*b3* – fine debris error,  
*b4* – coarse debris error  
*b5* – dielectric error,  
*b6* – internal temperature error,  
*b7* – external temperature error.

\*\*

Byte 3 values 0x00 to 0x08: bytes 4 to 7 are manufacturer specific  
 Byte 3 value 0x09: bytes 6 and 7 are sensor head temperature as 0.0625 °C / bit  
 Byte 3 value 0x0A: bytes 6 and 7 are electronics temperature as 0.0625 °C / bit

For use with WearDetect Oil Debris Sensor and accessories

### 7.7 Environmental

	Sensor Head	Inline Electronics & Cable	Display Electronics & Cable
Operational Temperature	-26°C to +150°C EN60068-2-1, ISO16750-4	-40°C to +85°C EN60068-2-1, ISO16750-4	-40°C to +85°C EN60068-2-1, ISO16750-4
Protection	IP68 / IP69k to EN60529	IP66/IP68 to EN60529	IP65 to EN60529
Humidity	95% RH +55 °C EN60945, EN60068-2-30 Test Db, ISO16750-4		
Thermal Shock	EN60945 EN60068-2-14 Test Na, ISO16750-4		
EMC	EN60945 (Marine) EN61000-6-3, EN61000-6-1 (Light industrial) EN61000-6-4, EN61000-6-2 (Heavy industrial) EN61326-2-1 (Measurement and control) EN13309 (Construction machinery) ISO 13766 (Earth moving machinery) ISO 14982 (Agricultural & Forest machinery) FCC ClassA Digital Device, part 15 *		
Vibration	EN60945 (Marine**) 3 axis, 2 to 13Hz, +/-1mm EN60068-2-6 (Industrial) 3 Axis, 10 to 55 Hz 0.75mm or 10g and 13.2Hz to 100Hz constant acceleration of 0.7g EN60068-2-27(Shock) 3 Axis, 25g, 6ms, 1000 cycles		
Chemical compatibility	Fuels, Oils, Coolants, Fluids, Diesel, Gasoline, Hydraulic, Gear, Motor, Vegetable, Synthetic ester, Polyalphaolefin, Polyglycol, Ethylene Glycol, water, Salt water		
Differential pressure	10 bar		
Cable pull	50 N all 3 axis		
General handling	1 m drop all 3 sides (in packaging)		

\* This equipment has been tested and found to comply with the limits for a Class A digital device, pursuant to part 15 of the FCC Rules. These limits are designed to provide reasonable protection against harmful interference when the equipment is operated in a commercial environment. This equipment generates, uses and can radiate radio frequency energy and, if not installed and used in accordance with the instruction manual, may cause harmful interference to radio communications.

\*\* Requires Loctite 270

For use with WearDetect Oil Debris Sensor and accessories

### 8. Maintenance

#### 8.1 Cleaning

The Oil Debris Sensor reports the amount of ferrous material attached to the sensor in real time. It is recommended that the sensor is investigated once the full scale output is reached.

To carry out investigation: Unscrew the complete thread adaptor and sensor assembly from the equipment using the correct spanner. The user can decide whether to remove the debris at this time or to re-install and increase the full scale alarm level.

*Note: To investigate debris build-up DO NOT remove the sensor probe from the thread adaptor while it is installed in the equipment: The Grub screw will need heat applied to overcome the Threadlock compound and avoid being damaged. The sensor probe will have attracted debris which will damage the internal O-rings if removed at this stage.*

It is recommended that the sensor is cleaned with a non-abrasive cloth prior to installation, removing any traces of used oil or metallic debris.

If the sensor is cleaned it can be removed from the thread adaptor as described in section 6, or (in any case) re-installed as a complete assembly

*Note: Abrasive cleaners or solvents must not be used to clean the Oil Debris Sensor*

#### 8.2 Servicing

There are no serviceable parts on your Oil Debris Sensor; however it is recommended that the following periodic checks are made:

- Periodically check your Oil Debris Sensor for oil leaks. If any oil leaks are observed, refer to the sealing notes in 8.4 and securely tighten the sensor into the gearbox or engine housing.
- Periodically check the tightness of the grub screws holding the sensor head to the thread adaptor.
- It is recommended that your Oil Debris Sensor zero/span/oil reference is checked periodically to ensure that your sensor is fully functioning using the Gill Oil Debris Monitoring Sensor configurator.
- Lid screws are fully fastened to prevent ingress into the electronics housing.
- Cable glands (Sensor with display models only) are fully fastened prevent ingress into the electronics housing.

*Note: To remove the assembly DO NOT remove the sensor probe from the thread adaptor while it is installed in the equipment: The Grub screw will need heat applied to overcome the Threadlock compound and avoid being damaged. The sensor probe will have attracted debris which will damage the internal O-rings if removed at this stage. Unscrew the complete thread adaptor and sensor assembly from the equipment using the correct spanner.*

For use with WearDetect Oil Debris Sensor and accessories

*Clean and remove the sensor probe for servicing in a suitable workshop.*

#### 8.3 Corrosion

All of the Oil Debris Sensor components are treated for protection against corrosion.

#### 8.4 Sealing

The thread adaptor is sealed to the oil enclosure with either a supplied hydrogenated nitrile (HNBR) bonded sealing washer (non-NPT), or a suitable sealing compound (NPT only). It is recommended that the seal is periodically checked for leaks and a new washer or sealant fitted if necessary.

O-Rings are used to seal the sensor head to the thread fitting adaptor. Under normal use the o-rings should not become damaged however, Gill recommend observing the o-ring seal periodically and replacing if necessary.

#### 8.5 Fault-finding

##### 8.5.1 Troubleshooting

**Q.** I can't access the Debris set menu

**A.** Both the fine and coarse channels are disabled from the sensor type menu.

**Q.** I can't set the fine channel;

**A.** The fine channel is disabled from the sensor type menu.

**Q.** I can't set the coarse channel

**A.** The coarse channel is disabled from the sensor type menu.

**Q.** I can't access the Water Contamination/temperature channel

**A.** The Water Contamination/temperature channel is disabled from the sensor type menu.

**Q.** I can't set the inhibit level;

**A.** The inhibit outputs during configuration function is disabled from the sensor type menu.

**Q.** The sensor output is greater than the zero level specified by the user (>0%) without debris present.

**A.** Check there is no debris present on the sensor and repeat the zero / tare step with the sensor installed in the application. Note: adjacent metalwork can cause a sensor offset and needs to be zero'd out after installation.

**Q.** The status LED's do not light up

For use with WearDetect Oil Debris Sensor and accessories

**A.** Turn up the brightness level.

### 8.5.2 Status (error) codes

To aid troubleshooting, the following status codes are shown in the Gill Configurator start up window:

Mechanical		
Code	Status	Description
OK	Normal Operation	Normal Operation
01	Temperature alarm	Temperature over/below threshold
02	Water Contamination high	Water Contamination above threshold
04	Water Contamination low	Water Contamination below threshold
08	Fine error	Fine channel error
10	Coarse error	Coarse channel error
20	Water Contamination error	Water Contamination channel error
40	Internal temperature error	Processing electronics temperature out of range
80	External temperature error	Sensor head temperature out of range

### 8.5.3 Communications (error) codes

If a communication error occurs a communications fail error message will be displayed in the Gill Configurator start-up window. Please check power and communication connections and restart the Gill Configurator.

### 8.5.4 Returning a Faulty Sensor

Should a fault arise during the use of your Oil Debris Sensor which is within the warranty period, or if you require a repair to your sensor please contact Gill Sensors & Controls for a Return Material Authorization number (RMA).

Please ensure any return units are cleaned prior to shipment.

For use with WearDetect Oil Debris Sensor and accessories

## 9. Appendices

### 9.1 Maximum Range Coarse Debris

The following maximum range numbers are provided as a guideline only and these numbers should be confirmed with actual coarse debris samples.

Course Debris	Material Type	Maximum No. Off
2mm	Chrome Steel Ball Bearing	>20
3mm	Chrome Steel Ball Bearing	20
4mm	Water Contamination high	Water Contamination above threshold
5mm	Chrome Steel Ball Bearing	10

*Note: Results may vary with more debris layers, different materials and positional variation.*

### 9.2 Maximum Range Fine Debris

The following maximum range numbers are provided as a guideline only and these numbers should be confirmed with actual fine debris samples.

Course Debris	Material Type	Maximum No. Off
1-6 µm	Iron Powder	0.41g
60 µm	Iron Powder	0.44g
125-300 µm	Iron Powder	0.43g
450 µm	Iron Fillings	0.48g
420-850 µm	Iron Fillings	0.35g

*Note: Results may vary with more debris layers, different materials and positional variation.*

### 9.3 Interaction between Coarse and Fine Channels

The coarse channel is not affected by the presence of fine debris particles.

The fine channel can be affected by the presence of a large amount of coarse debris, in excess of 2 x 2mm chrome steel ball bearings. In normal use the coarse channel operates independently of the fine channel.

It is recommended that during the set-up procedure the coarse channel is set to alarm when 1 x 2mm chrome steel ball bearing is on the sensor head to give the earliest warning of a significant failure.

For use with WearDetect Oil Debris Sensor and accessories

### 9.4 Guideline Oil Reference Number

The following oil reference numbers are provided as a guideline only and these numbers should be confirmed with actual oil samples.

Course Debris	Material Type	Maximum No. Off
Air	Green	1000-1015
Water	Red	860
Oil	Green	990

### 9.5 Grounding Schemes and Recommendations

The Oil Debris Sensor complies with International EMC standards. In order to maintain compliance with these standards it is essential that the electrical installation is engineered correctly. Electrical installation standards and practices vary for different countries and installation companies. It is the responsibility of the electrical installation design authority to determine the applicable standards / practices and ensure compliance with them. When designing electrical installations for the Oil Debris Sensor it is recommended that the design authority considers the following:

- For the Sensor with display models, a safety earth connection can be made by a wire connected to the unit's external earthing point.

When deciding how to earth the unit, consideration should be given to the recommendations below.

- Ideally, the cases of both the units and the sensor should not be connected to electrically noisy (dirty) metalwork or conductors. Preferably, they should both be connected to a low noise instrument (clean) earth.
- For the display electronics enclosure, the field cable's screen should be connected to the sensor screen via the terminations provided within the enclosure, providing a single, continuous earth screen connected to a low noise instrument (clean) earth. This connection must not be allowed to complete an earth loop or connect instrument earth to safety earth.
- If armoured cable is being used it is necessary to prevent safety (dirty) earth from becoming connected to instrument (clean) earth via the earth connections inside the enclosure. This is most easily achieved by the use of insulating cable glands for the field cable entry.
- If it is not practical to isolate the unit's case from safety (dirty) earth the enclosure should be earthed in a manner that complies with local regulations.

For use with WearDetect Oil Debris Sensor and accessories

### 9.6 Oil Debris Sensor parts

Your Oil Debris Sensor consists of the following parts:

#### Sensors without display

- Oil Debris Sensor prewired with inline electronics unit
- Quickstart guide

#### Sensors with display

- Oil Debris Sensor
- Enclosure electronics unit with local visual display
- Crimp type Bootlace ferrules.

#### Sensor Head Adaptor (Mandatory)

- Sensor Head mounting adaptor (see data sheet)
- Quick Start Guide

#### Inflow Adaptor Kit (Optional)

- Oil Debris Sensor Inflow sensor head mounting (Equal Tee 1.5")
- 1.5" BSP ball valves x 2 (4212-00-160-150 model) (Fits pipe diameters 1.25" – 1.5")
- 1" BSP ball valves x 2 (4212-00-160-100 model) (Fits pipe diameters ½", ¾" & 1")
- BSP pipe size reducers x 2 (1.5" – 1") (4212-00160-100 model)
- Mounting brackets x 2

#### Inflow Adaptor (Optional)

- Oil Debris Sensor Inflow sensor head mounting (Equal Tee 1.5")

### 9.7 Packaging

The packaging has been designed to protect the sensor during transportation. Carefully unpack the equipment, observing any instructions that may be printed on or contained in the packaging, and check the contents for transit damage. Dispose of the packaging according to local regulations.

### 9.8 Accessories

An optional conduit kit (Gill part No. 4212-10-051-X) is offered for additional cable protection of the Sensor with display models. The X suffix is the length of the conduit tube in meters. The conduit kit consists of the following components:

For use with WearDetect Oil Debris Sensor and accessories

### 9.9 Product variants

Part No.	Variant
4212-PK-145	Sensor with display models 4-20mA output
4212-PK-146	Sensor with display models 0-10V output
4212-PK-147	Sensor with display models CAN output
4212-PK-148	Sensor without display models 4-20mA output
4212-PK-149	Sensor without display models 0-10V output
4212-PK-150	Sensor without display models CAN output

All product variants require a thread adaptor to allow installation with the chosen equipment. See section 6 for a list of the available adaptors at the time of writing. Gill recommend getting in contact as these are constantly being updated according to demand.

#### 9.9.1 Optional

Part No.	Variant
4212-00-160-150	Inflow Adaptor Kit 1.5" (Also fits 1.25")
4212-00-160-100	Inflow Adaptor Kit 1" (Also fits 0.75" & 0.5")
4212-00-161	Inflow Adaptor

### 9.10 Sensor De-commissioning

#### 9.10.1 Uninstall the Oil Debris Sensor Configurator App

Launch the Oil Debris Sensor configurator uninstall software application from your program file location selected during installation.

Alternatively, open Control Panel>Programs and Features and select the Oil Debris Sensor Configurator from the list and select the Uninstall option to remove your Oil Debris Sensor configurator software from your PC.

For use with WearDetect Oil Debris Sensor and accessories



## DECLARATION OF CONFORMITY

In accordance with BS EN ISO/IEC 17050-1:2010

Document Number	DoC – 4212-PK-1XX – 2021-03-12
Company	Gill Sensors and Controls Limited, Ampress Park, Lymington, SO41 8LW, UK
Product Description	Oil Debris Sensor
Part Numbers	4212-PK-145, 4212-PK-146, 4212-PK-147, 4212-PK-148, 4212-PK-149, 4212-PK-150

We hereby declare that the following EU Directives, Standards and Regulations listed below have been applied

Ref No.	Title
2014/30/EU	Electromagnetic Compatibility (EMC) Directive
2011/65/EU	Restriction of Hazardous Substances (RoHS) Directive
2012/19/EU	Waste Electrical and Electronic Equipment (WEEE) Directive
BS EN 60945:2002	Maritime navigation and radio communication equipment and systems. General requirements. Methods of testing and required test results.
BS EN 61326-2-1:2013	Electrical equipment for measurement, control and laboratory use. EMC requirements. Particular requirements.
BS EN 61000-6-2:2005	Electromagnetic compatibility (EMC). Generic standards. Immunity for industrial environments.
EN 61000-6-3:2007 + A1:2011	Electromagnetic compatibility (EMC). Generic standards. Emission standard for residential, commercial and light-industrial environments.
BS EN 61326-1:2013	Electrical equipment for measurement, control and laboratory use. EMC requirements. General requirements.

Signatory	Elizabeth Phillips
Position	Director
Date of Issue	2021-03-12
Signature	



For use with WearDetect Oil Debris Sensor and accessories

### Important Notices:

- Gill Sensors & Controls Limited can take no responsibility for installation and/or use of its equipment if this is not done in accordance with the appropriate issue and/or amendment of the manual.
- The user of this manual should ensure that it is appropriate in all details to the exact equipment to be installed and/or operated. If in doubt, the user should contact Gill Sensors & Controls Limited for advice.
- If further details are required which do not appear in this manual, contact Gill Sensors & Controls Limited or one of their agents.
- Install and use the Oil Debris Sensor in accordance with the local regulations.
- Gill Sensors & Controls Limited reserve the right to change or revise the information supplied in this document without notice and without obligation to notify any person or organisation of such revision or change.

### Help Us to Help You:

Every effort has been made to ensure the accuracy in the contents of our documents, however, Gill Sensors & Controls Limited can assume no responsibility for any errors or omissions in our documents or their consequences. Gill Sensors & Controls Limited would greatly appreciate being informed of any errors or omissions that may be found in the contents of any of our documents.

### After Sales Support

Should you require after sales assistance with this product, please go to [www.gillsc.com](http://www.gillsc.com) where you can request support by clicking on the "Get Support" button and filling out the form. Alternatively, call us during UK office hours on 01590 613900 (UK). Please have details of the product and serial number whenever possible.

Additionally, you can access further information on the product from the support section of the website at [www.gillsc.com/support](http://www.gillsc.com/support)

Gill Sensors & Controls Limited  
Unit 600, Ampress Park, Lymington,  
Hampshire, SO41 8LW, UK  
Tel: +44 1590 613900, Fax: +44 1590 613901  
Email: [info@gillsc.com](mailto:info@gillsc.com), Website: [www.gillsc.com](http://www.gillsc.com)